

# User Manual

Home Mobile Signal Booster

4K Plus  
4K Plus Pro  
10K Plus  
10K Plus Pro

3150 Premier Drive, Suite 130,  
Irving, TX 75063  
(972) 870-5666  
service@hiboost.com  
www.hiboost.com





# CONTENTS

Package Content.....	01
Introduction .....	03
Pre-Installation Instructions.....	04
light pattern.....	11
APP Assisted Installation .....	13
LCD Assisted Installation .....	28
Quick Troubleshooting Guide.....	40
Technical Specifications.....	43
Authorized Accessories List .....	44
FCC and IC Statements .....	45
Return and Warranty Policies .....	48

# Package Content

## HiBoost 4K/10K Plus



Outdoor Antenna



Outdoor Cable  
49.2 ft NM-SMAM



Outdoor Cable  
16.4ft SMAF-NM

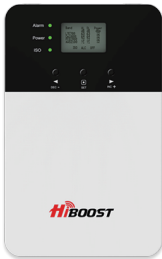

Signal Booster



Power Supply

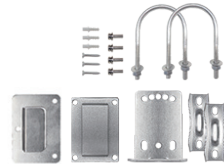

Accessories for main parts



Waterproof tape



Through-Window Cable

# Package Content

## HiBoost 4K/10K Plus Pro



Outdoor Antenna



Outdoor Cable  
49.2 ft NM-SMAM



Through-Window Cable



Outdoor Cable  
16.4ft SMAF-NM

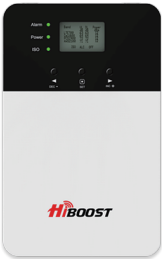

Signal Booster



Power Supply

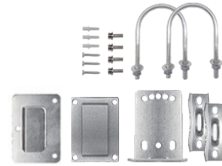

Accessories for main parts



waterproof



Indoor Antenna



Indoor Cable  
30 ft NM-SMAM

**NOTE:** Available accessories can be purchased through [HiBoost.com](http://HiBoost.com)

**Warning:** Un-authorized antennas, cables, and/or coupling devices are prohibited by new FCC rules. Please contact FCC for details: 1(888)-CALL-FCC

# Introduction

Thanks again for purchasing HiBoost cell Booster. The HiBoost Plus/Pro series is a collection of precision-engineered products that improve cellular reception inside of homes and businesses by amplifying incoming and outgoing cell phone signals.

Both HiBoost Plus and Plus Pro have built-in antennas, so both can directly receive and send signals through boosters. But Plus Pro has one more indoor antenna to facilitate the need to cover more rooms.

HiBoost Plus/Pro exclusive cloud-based Signal Supervisor mobile application and LCD display allow users to monitor the live status of HiBoost Plus/Pro cell phone signal boosters directly from the LCD display or remotely from a mobile device anywhere at any time.

If there are any issues while installing a HiBoost Plus/Pro cell phone signal booster, please contact the HiBoost technical support team through the following options:

**Online Support:** Create a ticket or chat via Signal Supervisor App

 (972) 870-5666 (M-F from 9 am – 5 pm CST)

 [service@hiboost.com](mailto:service@hiboost.com)

 [www.hiboost.com](http://www.hiboost.com)

# Pre-Installation Instructions

We strongly recommend you to read the user guide completely before you install.

HiBoost 4K/10K Plus/Plus Pro provide 2 options of booster installation, APP and LCD installation ways are unique methods provided by HiBoost

## 1. App assisted installation, **FIRST CHOICE From Page 13~27.**

It's more convenient and many work could be done by ONE person, and the most important is that the obtained signal can be very precise.



The App helps you find the best signal outside

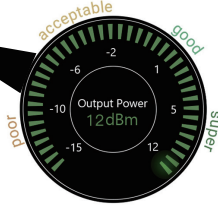

## 2. LCD assisted installation, **SECOND CHOICE From Page 28 ~39.**

It can achieve the same precise effect as App guidance. But it may need two people and the installation process is a little cumbersome.

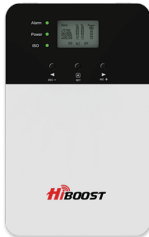



LCD signal meter tells how strong the signal is

Band	UL dB	DL dB	Power dBm
LTE700	63	63	12
Ce11800	64	64	12
PCS1900	65	65	12
AWS2100	65	65	12
ISO	ALC	OFF	

## Then why has HiBoost spent extra big efforts and costs to design APP and LCD signal meters to help you install?

Out of the various reasons, the most important reason is that we would like you, our valuable client, to get the maximum output power from the booster system in order to get optimal signal reception for all your mobile devices.

 As it is known and a big thanks, FCC makes signal boosters legal in 2014 so that everybody can install and benefit from the signals;

 But FCC regulations do limit the gain and output power of all consumer boosters to low values in order to avoid any interference to the cell towers;

 Furthermore FCC stipulates that any improper install should trigger immediately further reduction of the booster's already-limited gain and power to protect the towers.

 Therefore, you can understand how important you need to find the perfect outside signal from the tower and how important to squeeze every last gain and power from the booster, even 1dB more power is so precious when you suffer from no signals.

HiBoost App & LCD signal meters will help you to fine tune the best power and get as much cover of your spaces.

## General Working Principle:

Before we start any of the two ways, please allow us to spend 3 pages to make you understand how the booster system works for you.

※ Please do spend sometime to read it fully, as it is crucial to get full bars for your rooms.

## How HiBoost Booster works

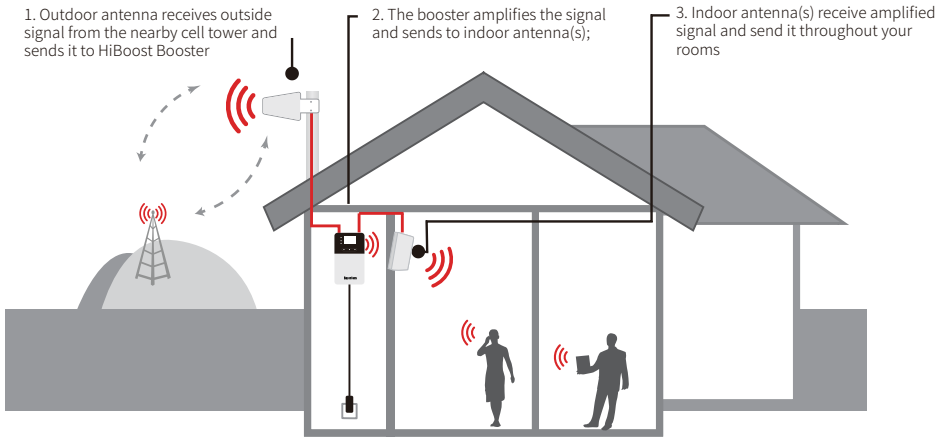

Vice versa, booster(plus)/indoor antenna receives cellphone signal and sends to the booster  
The booster then amplifies the signal and sends it to outdoor antenna  
Outdoor antenna sends signal to the cell tower  
Then you can make phone calls and internet streaming.



## Built-in Antenna Method

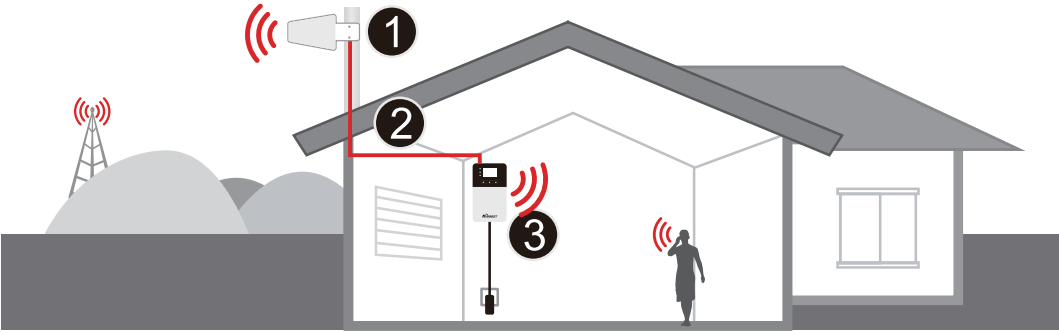

- 1 -Outdoor wide band Directional antenna
- 2 -Hiboost240 low-loss cable
- 3 -Home Plus with built-in antenna

Noted: applicable to 4K plus and 10K Plus

## Optional Antenna Methods

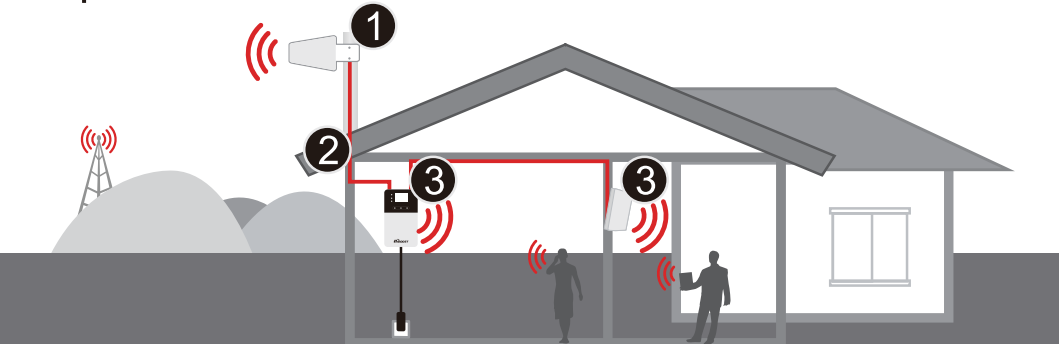

- 1-Outdoor wide band Directional antenna
- 2-Hiboost240 low-loss cable
- 3-You can add an indoor panel antenna and Hiboost240 low-loss cable to extend the coverage

Noted: applicable to 4K Plus Pro and 10K Plus pro; or 4K plus and 10K Plus with purchased secondary indoor antenna

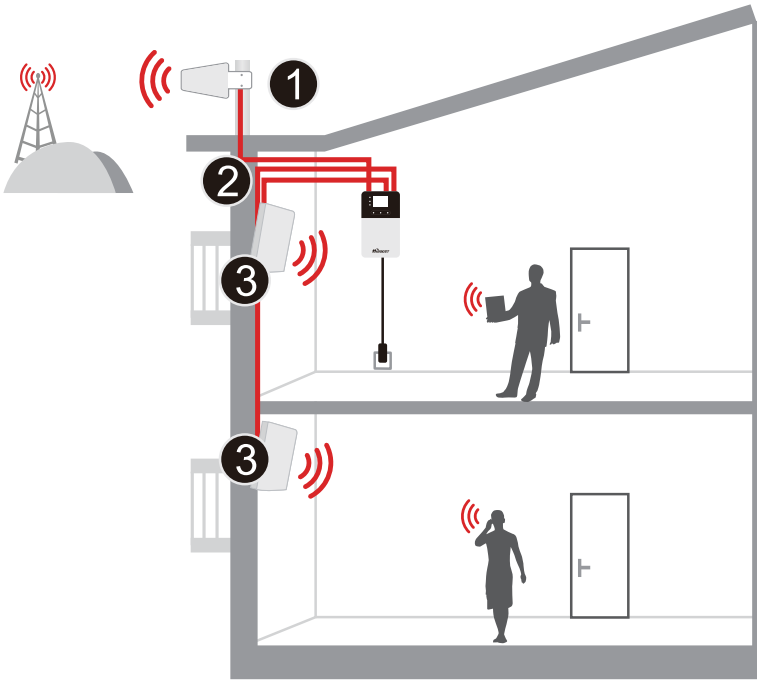

1-Outdoor Wide Band Directional Antenna

2-Hiboost240 Low-loss Cable

3-You can add 3<sup>rd</sup> indoor antenna kit with SMA-N connector to extend the coverage. (Built-in antenna will be automatically disabled)

Noted: applicable to Plus and Pro Series when 3<sup>rd</sup> indoor antenna is added

# Working Principle in Formula

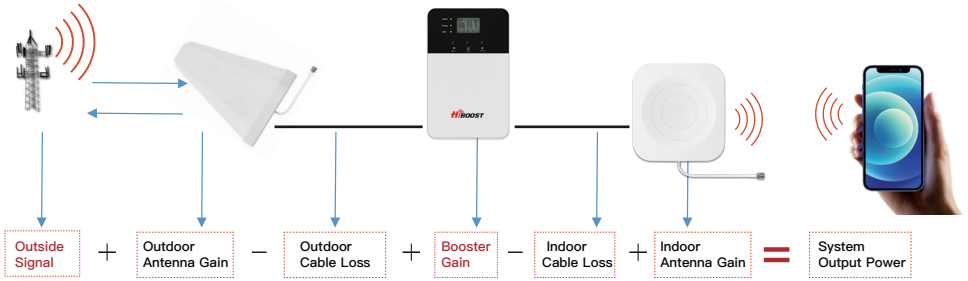

Out of the Formula:

**Outside Signal:** To be received by outdoor antenna from cell tower

Outdoor Antenna Gain: The gain of outdoor antenna

Outdoor Cable Loss: The loss of the outdoor cable

**Booster Gain:** The actual working gain of the booster

Indoor Cable Loss: The loss of the indoor cable

Indoor Antenna Gain: The gain of indoor antenna

## For example:

**-70dBm + 11dBi - 4.5dB + 65dB - 2dB + 7dBi = 6.5dBm (System Output Power)**

Since the figures in **Black** color are fixed when you finish the purchase, thus the **RED** figures of

**1. Outside Signal**

**2. Booster Gain** will play a vital role in reaching the best output power during the install, especially when we know the FCC limits the booster system values.

So the user guide is focused on:

1. Getting the best outside signal.
2. Keeping the maximum booster gain.

# More notes on how to keep the maximum booster gain

The loop back from the outdoor antenna to the indoor antennas will reduce the gain, so the principle to keep the maximum booster gain is to avoid the loop back from the outdoor antenna to the indoor antennas.

1) Increase the distance between the outdoor and indoor antennas, generally the same vertical distance generates more loss than horizontal, and to follow easily, a Typical Required Distance Between Outdoor and Indoor Antennas Over 30 feet (10 meters) horizontal distance or 13 feet (4 meters) vertical distance.

2) The outdoor and indoor antennas shall be back to back.

3) To use barriers between the indoor and outdoor antennas.

※ Please note: This separation is not an absolute mandate. The idea is to isolate the outdoor antenna from the two indoor antennas.

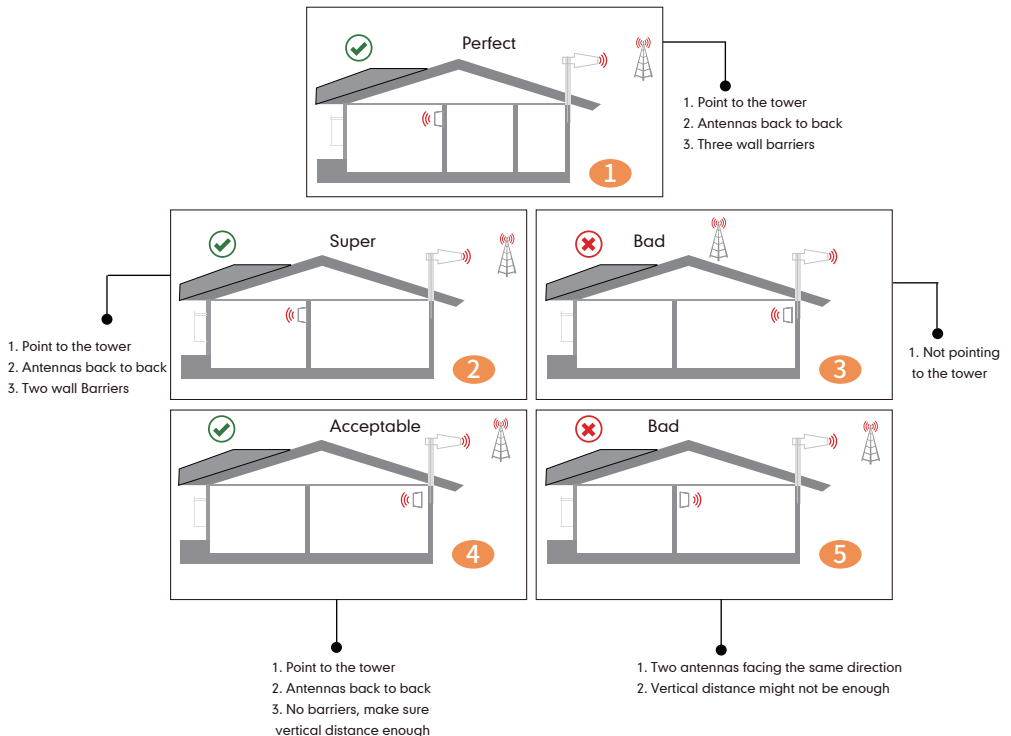

# Notes about LCD Display

These are instructions that will allow users to install a Barsguard cell phone booster using the LCD Display.

Following LED status indicators and control buttons on the booster .

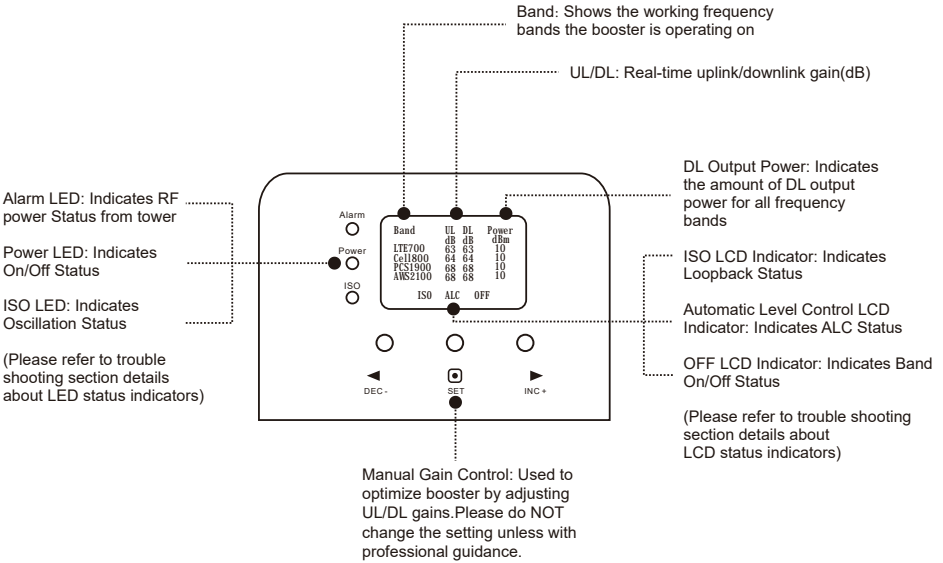

LED STATUS INDICATORS		
LED	STATUS	INDICATION
Alarm LED	GREEN	Below full output power
	SLOW FLASHING GREEN	Full output power
	QUICK FLASHING GREEN	Output power is too high
	QUICK FLASHING RED	Booster will automatically shut off due to excessive DL signal from tower
Power LED	GREEN	Normal
	OFF	DC Power Problem
ISO LED	GREEN	Normal
	SLOW FLASHING GREEN	Slight loopback or self-oscillation
	QUICK FLASHING GREEN	Deep loopback or self-oscillation
	QUICK FLASHING RED	Booster is automatically shutting off

## Bands contained in the Gauges

Gauge	Band	Uplink	Downlink
LTE700	12/17	698-716MHz	728-746MHz
	13	776-787MHz	746-757MHz
CELL800	5	824-849MHz	869-894MHz
PCS1900	25/2	1850-1915MHz	1930-1995MHz
AWS2100	4	1710-1755MHz	2110-2155MHz

Please focus on the gauge that contains the band you are using.

# APP Assisted Installation

## Flow chart of App Assisted Installation

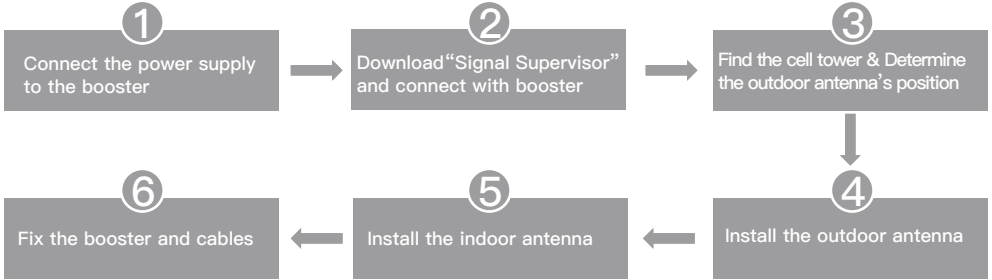

### Step 1: Connect the power supply to the booster



Power Supply

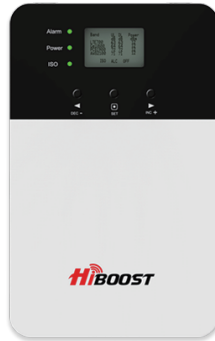

Signal Booster

## Step 2: Download Signal Supervisor APP and connect the booster

Download the Signal Supervisor App, register ID and booster.



1) Search "Signal Supervisor" on Google Play/ App Store, or scan the above QR Code to download.

2) Register on the Signal Supervisor APP.

3) Power on the booster

\* The Bluetooth/WiFi antenna is built in, there is no need to connect outdoor or indoor antennas at this moment.

4) Click "Add Device" to register the booster into the APP. And we recommend WiFi connection because the Bluetooth connection can't go beyond 30ft. Check more steps about the App uses as below.



1

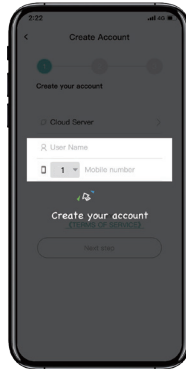

2

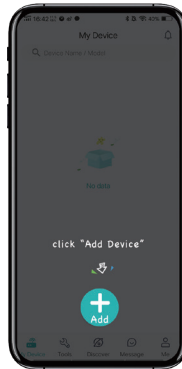

3



4

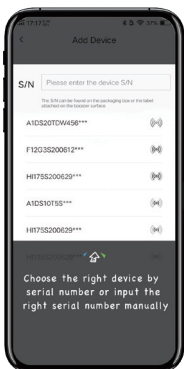

5

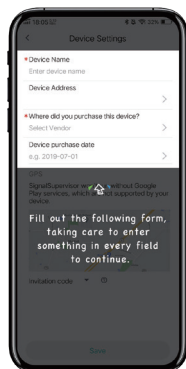

6



7

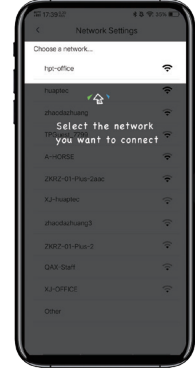

8



## Bands contained in the Gauges

Gauge	Band	Uplink	Downlink
LTE700	12/17	698-716MHz	728-746MHz
	13	776-787MHz	746-757MHz
CELL800	5	824-849MHz	869-894MHz
PCSI900	25/2	1850-1915MHz	1930-1995MHz
AWS2100	4	1710-1755MHz	2110-2155MHz

Please focus on the gauge that contains the band you are using.

Remark: Due to the variety of phone models and the WiFi router types, there is a situation, though it is rare, where the booster cannot be linked to the Signal Supervisor app successfully. If such situation is encountered:

\* You can alternatively use LCD signal meter to assist your installation. And Bluetooth/Wi-Fi disconnection won't influence the booster working status at all.

\* Or please use another cell phone or change a WiFi router if you insist an app assisted installation.

Please contact our tech support if you have difficulties in installation, and we will provide the best solution for you.

## Step 3: Seek best outside signal and install outdoor antenna

### 3.1 Find the band you are using

For Android

Download NetWork Cell Info Lite in the Google store and open it.

It can be seen from the example picture that the frequency band is band 13.

(According to the form before, you need to pay attention to Gauge LTE700)

Then click MAP. You can see your phone connecting to a tower, and you can try aiming your outdoor antenna at it. But sometimes this is not accurate. You could also move to Step 3.2 to find the tower

Note: Please take screenshots at this stage.



For ios

(1) Dial \*3001#12345##\*

(2) Follow the instructions, take the screenshot as required.

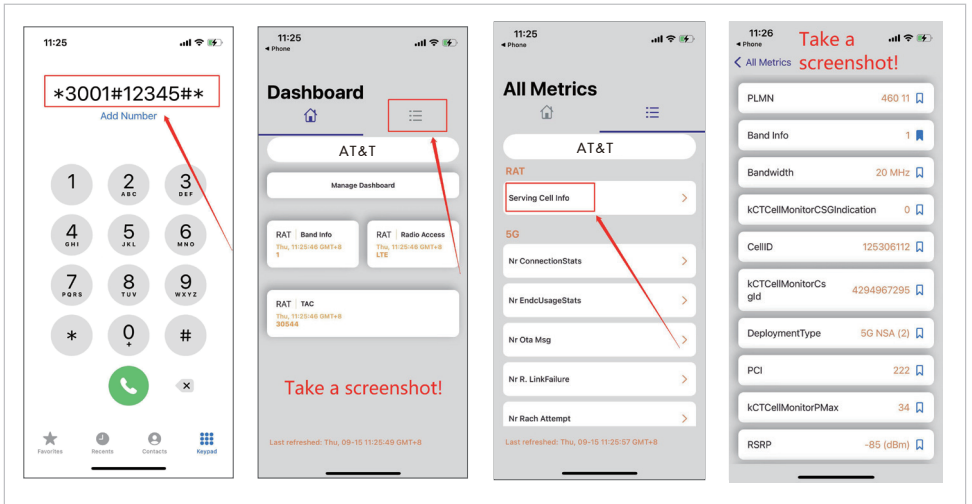

### 3.2 Find the cell tower

(1) Enter cellmapper.net

(2) Choose your own carrier and band here.

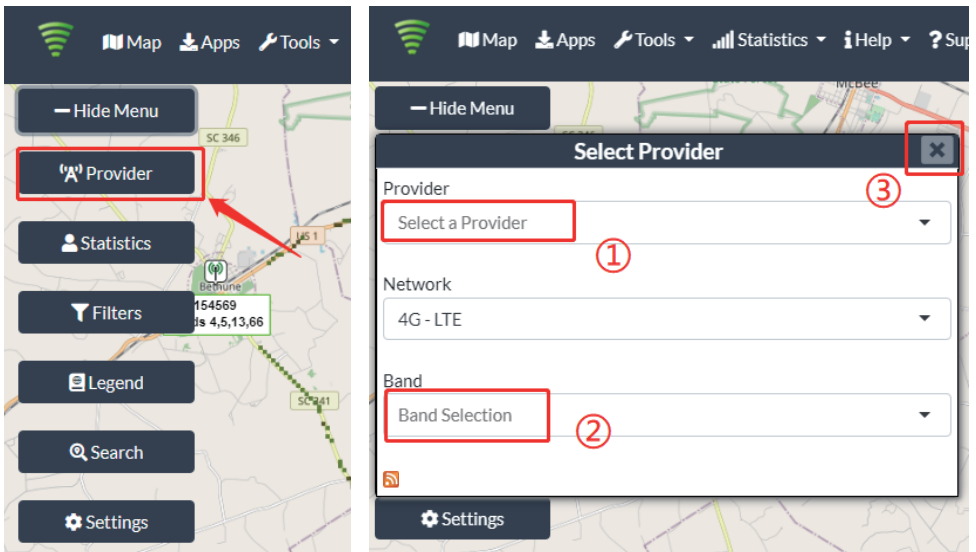

(3) Then enter the coordinate of where you are trying to install the signal booster, and press Enter key.

(In fact when you open Cellmapper, the map on the right will automatically locate your area if give the site permission to access your location.

If you found tower sites not even displayed on the map, it might because the app intercepts the locations for security reasons.)

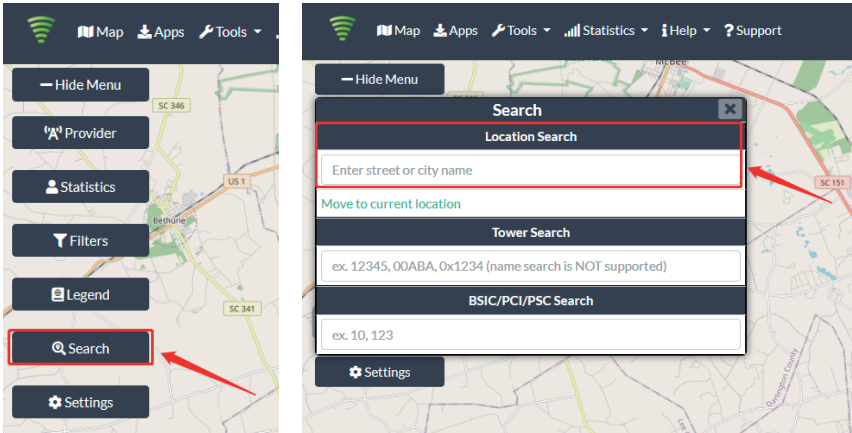

(4) After the map jumps to the location, you can scroll the mouse pulley and zoom it out, then you will see the tower near the location. It would be better to take a screenshot of this page to guide the following installing steps. Should you have any questions, please contact our tech support.

Note: If you need help finding the tower, please contact our tech support and provide your carrier, band and screenshots taken in the last steps.

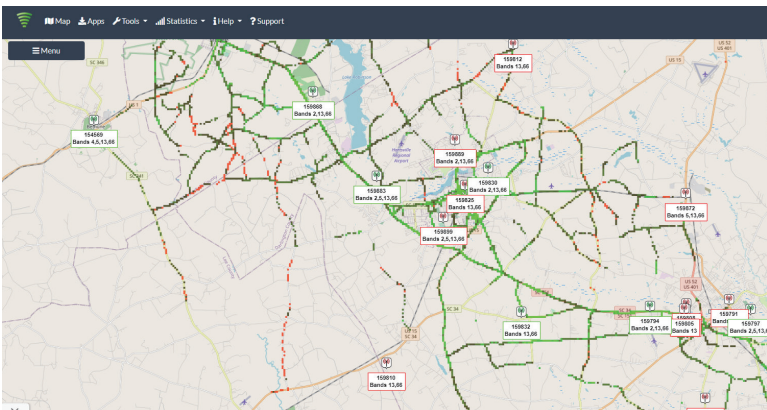

### 3.3: Determine the outdoor antenna's position

The outdoor antenna is usually placed at one of the 4 ends of the roof. Please choose the position according to the tower's location. Make sure there are no barriers between the antenna and the tower.

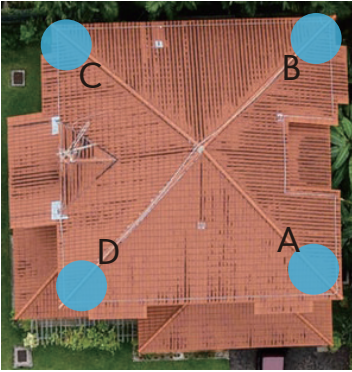

### Step 4: Install the outdoor antenna

The performance of the booster system is heavily dependent on the successful installation of the outdoor antenna

#### 4.1 Connect the booster with outdoor antenna

- (1) Put the booster near to the location you would like to install in the future, or a place with power outlet temporarily.
- (2) Switch on the booster and make sure the signal supervisor app links with it smoothly.
- (3) Connect the 16.4ft cable with the booster's outdoor port. The booster supports hot plug.
- (4) Then connect the window cable with 16.4ft cable and pull the window cable outside and connect it with 49.2ft cable. In case window cable is not needed, connect the 16.4ft cable with 49.2ft cable directly.
- (5) Connect the other side of 49.2ft cable with the outdoor antenna.

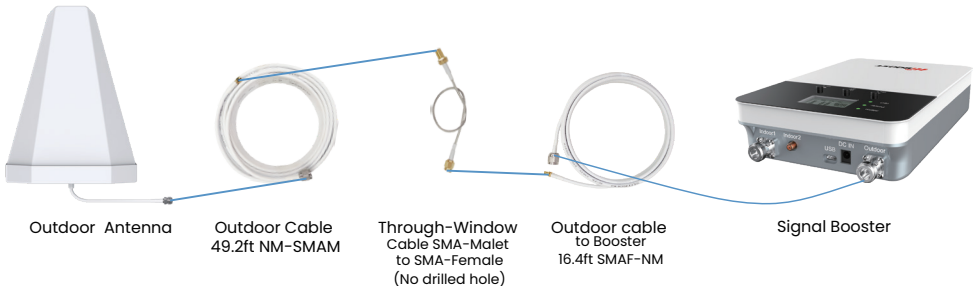

Notes:

\*Please don't connect indoor antenna at this moment as it will influence the outside signal finding.

\*Please place the booster within 30ft to the possible installation location of outdoor antenna

## 4.2 Adjust and fix the outdoor antenna



Notes:

1) Have your outdoor antenna pointed to the cell tower you found before and observe the reading on the app. Adjust the outdoor antenna accordingly.

2) Try to get the highest possible output power for each band and try to make 2-3 gauges turn green.

3) You can either observe the signal meter value (full output power is the best) or the signal description (Super is the best).

4) The full output power for 4k Plus/ 4k Plus Pro is 10dbm. And the full gain is 65dB. The full output power for 10k Plus/ 10k Plus Pro is 12dbm. And the full gain is 68dB.

## Professional Tips

- Keep in mind that it is normal for the output values may vary dynamically between 1-3 dB
- To optimize the signal for one carrier, point the outdoor antenna towards the closest cell phone tower designated to that carrier
- To optimize the signal for more than one carrier, point the outdoor antenna between multiple towers
- Make sure to slowly turn the antenna while taking the readings so the booster has time to adjust the reading
- Test and install the antenna at the same height where power outputs and gain values reach the booster's maximum capacity
- If you can't get a good output power, for instance, the value is below POOR level, it is highly likely that the installation will fail. Please either find a new place with better signal or drop the installation.

### 4.3 Fix outdoor antenna

Now install the outdoor antenna firmly

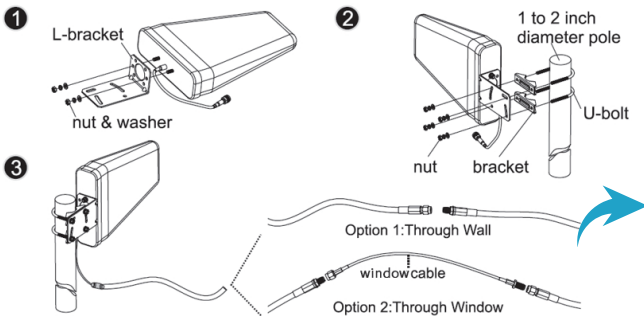

The connector of the cable connection part must be glued with black waterproof tape to prevent long-term signal drop and reduce signal loss!



#### 4.4 Reconfirm that the signal on signal gauge is the best!

Please **do take following screenshot** for future comparison during indoor antenna install.

The thing you need to pay attention to here is the gain values. If there's interference between your indoor and outdoor antennas, the gain will get lower and these values will decrease.



### Step 5: Install the indoor antennas

#### 5.1 Install the booster and the cables

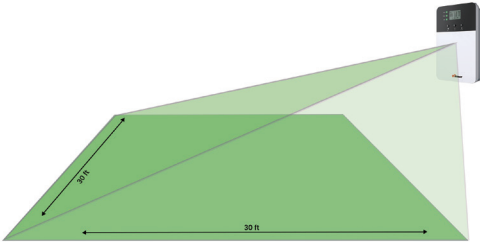

Since there's a built-in indoor antenna in 4K/10K Plus and 4K/10K Plus Pro, the booster shall be installed as a panel antenna. Please have your booster pointed to the area you would like to cover with signal.

#### 5.2 Signal quality test

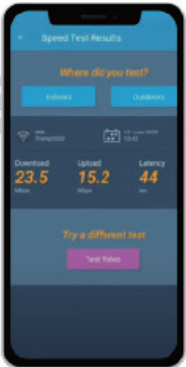

You could do the following:

- (1) First make sure the signal gauge value is unchanged from that during the outdoor antenna installation.
- (2) Do speed tests with the booster on and off, and make a comparison.
- (3) Check if the number of signal bars increases.
- (4) Make a phone call or send messages and check if the voice and streaming are better.



Please skip to Step6 if you use 4k/10k plus.

### 5.3 Connect the indoor antenna with the booster(For 4k/10k plus pro)

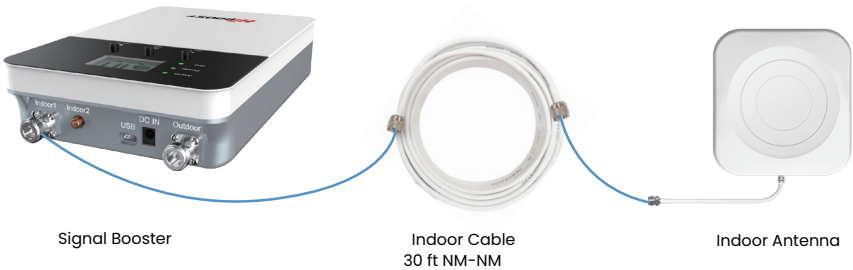

### 5.4 Adjust the indoor panel antenna

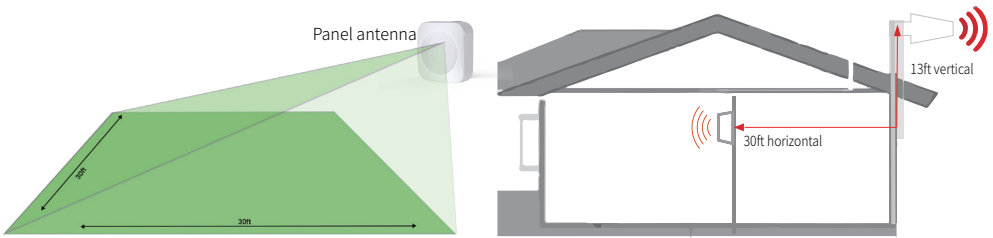

Have your indoor antenna pointed to the area you would like to cover with signal.

#### Notes:

- (1) It would be best if you could make the outdoor antenna and the two indoor antennas face opposite directions.
- (2) For 4K Plus Pro, please make sure the gain reaches about 60dB. If not, please adjust the direction of the indoor antenna/increase the vertical and horizontal distance between the two antennas/add some barriers.
- (3) For 10K Plus Pro, please make sure the gain reaches about 65dB. If not, please adjust the direction of the indoor antenna/increase the vertical and horizontal distance between the two antennas/add some barriers.

## Two requests of indoor antenna installation

- A. Radiation shall be good enough to cover whole space
- B. Loopback shall be avoided



### Tips to avoid loopback

1. Increase the distance between the outdoor and indoor antennas
2. The outdoor and indoor antennas shall face opposite directions
3. Utilize barriers between the indoor and outdoor antennas

## 5.5 Signal Quality test

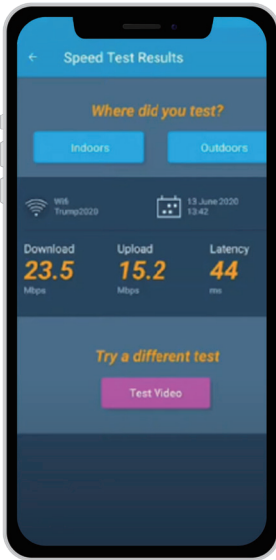

You could do the following:

- (1) First make sure the signal gauge value is unchanged from that during the outdoor antenna installation.
- (2) Do speed tests with the booster on and off, and make a comparison.
- (3) Check if the number of signal bars increases.
- (4) Make a phone call or send messages and check if the voice and streaming are better.

If the test is good, then congratulations, the indoor antenna position has been successfully found. Please install the panel antenna.

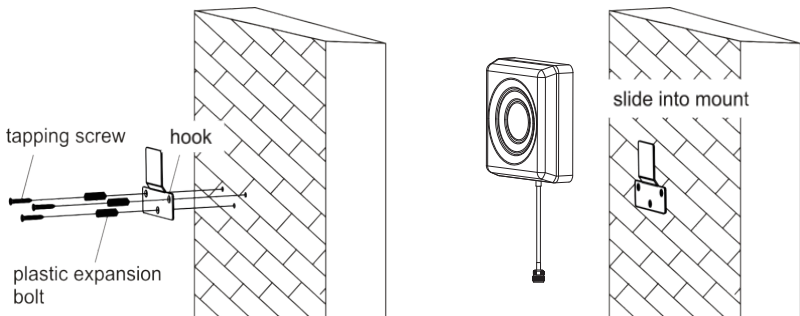

## 5.6 Use an extra panel antenna(optional)

If the built-in antenna is far away from the area you would like to cover with signal due to the location of power source, you could buy an extra indoor antenna kit. And follow Step 5.3-5.5 to install the antenna again.

Note:

- (1) The built-in antenna will be disabled when the indoor2 port is occupied.
- (2) The connector of indoor2 port is SMA-Female, please make sure you buy the right cable.

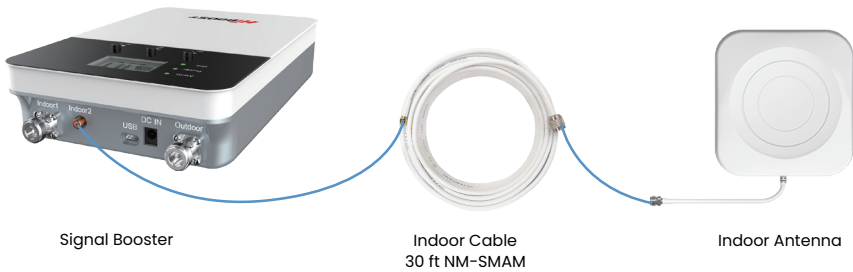

## Step 6: Install the booster and the cables

Mount the signal booster in a dry and cool area, and it shall be easily accessible for maintenance.

And run the cables neatly, please do use the **water-proof tape** to protect all outside connections from the weather.

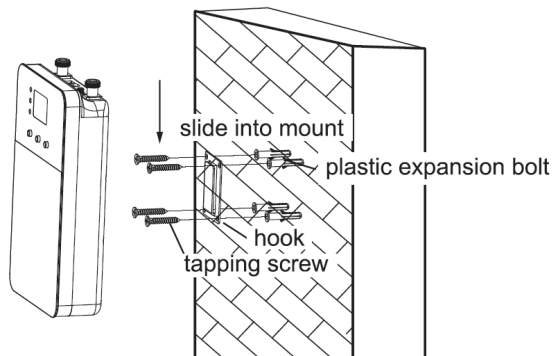

**Test again the performance after installation is done**

- a. First make sure the Signal gauge value is unchanged from that during the outdoor antenna installation.
- b. Test with a third-party app, make sure calls and network data iare smooth in most indoor

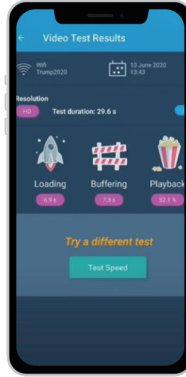
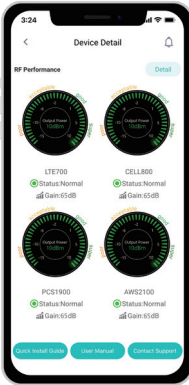

Now everything is completed and please start to enjoy the mobile services. If the result is not satisfactory or you want to be better, you may repeat the whole or part of the process to improve. Should you have any queries during the installation, please kindly contact us via Signal Supervisor App online support.



# LCD Assisted Installation

## Flow chart of LCD Assisted Install

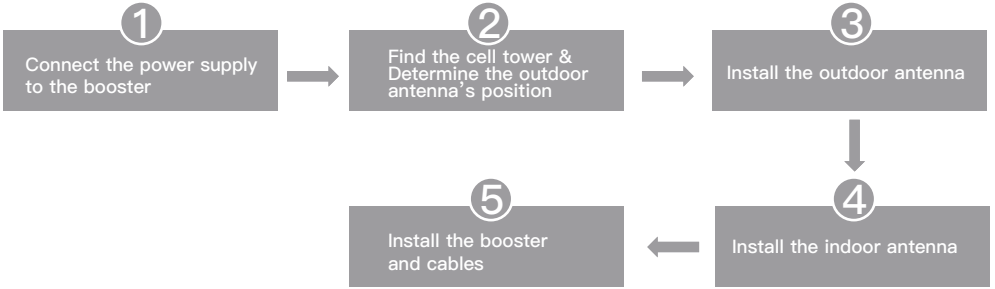

### Step 1: Connect the power supply to the booster



Power Supply

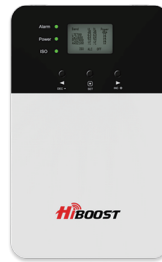

Signal Booster

## Step 2: Seek best outside signal and install outdoor antenna

### 2.1 Find the band you are using

#### For Android

Download NetWork Cell Info Lite in the Google store and open it.

It can be seen from the example picture that the frequency band is band 13.

(According to the form before, you need to pay attention to Gauge LTE700)

Then click MAP. You can see your phone connecting to a tower, and you can try aiming your outdoor antenna at it. But sometimes this is not accurate. You could also move to Step 2.2 to find the tower

Note: Please take screenshots at this stage.



For ios

(1) Dial \*3001#12345#\*

(2) Follow the instructions, take the screenshot as required.

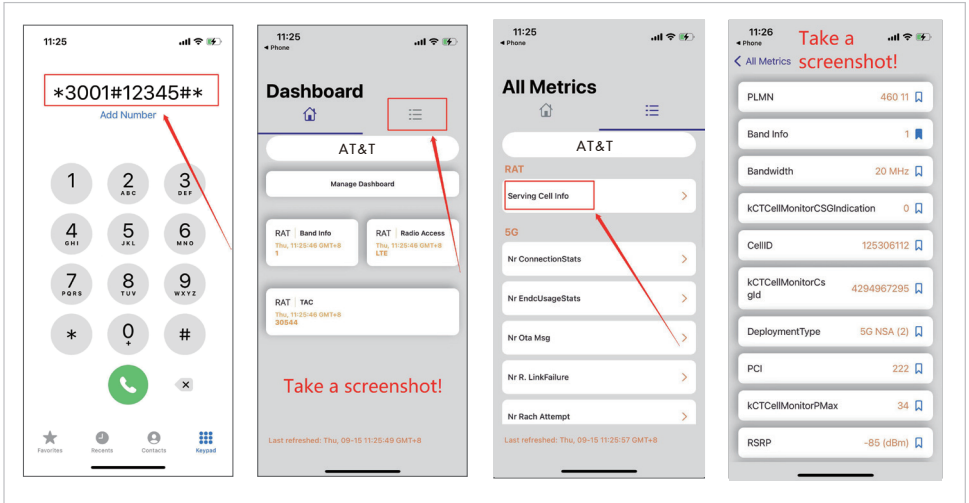

## 2.2 Find the cell tower

(1) Enter cellmapper.net

(2) Choose your own carrier and band here.

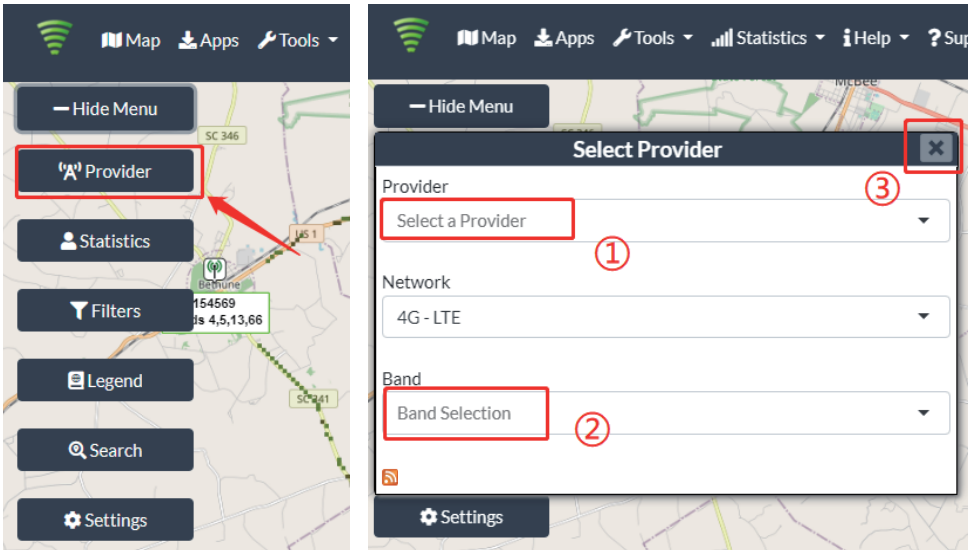



(3) Then enter the coordinate of where you are trying to install the signal booster, and press Enter key.

(In fact when you open Cellmapper, the map on the right will automatically locate your area if give the site permission to access your location.

If you found tower sites not even displayed on the map, it might because the app intercepts the locations for security reasons.)

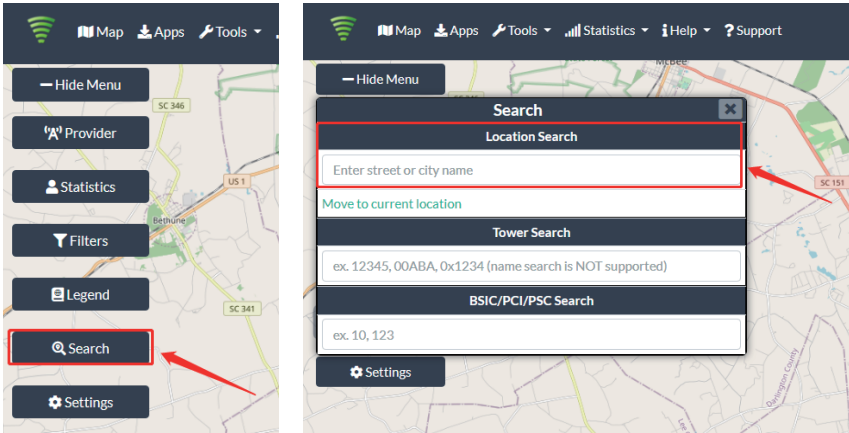

(4) After the map jumps to the location, you can scroll the mouse pulley and zoom it out, then you will see the tower near the location.

It would be better to take a screenshot of this page to guide the following installing steps. Should you have any questions, please contact our tech support.

Note: If you need help finding the tower, please contact our tech support and provide your carrier, band and screenshots taken in the last steps.

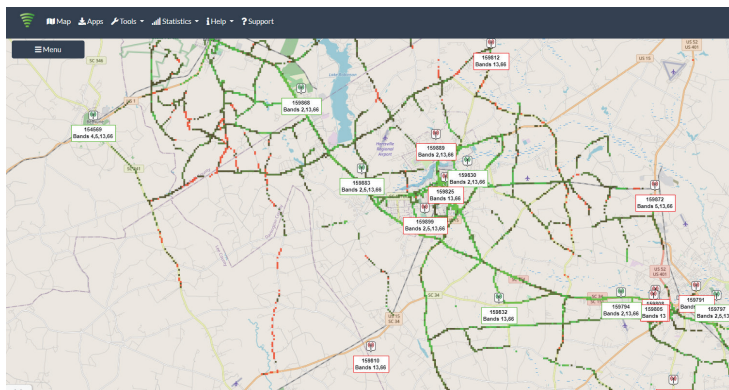

## 2.3 Determine the outdoor antenna's position

The outdoor antenna is usually placed at one of the 4 ends of the roof. Please choose the position according to the tower's location. Make sure there are no barriers between the antenna and the tower.

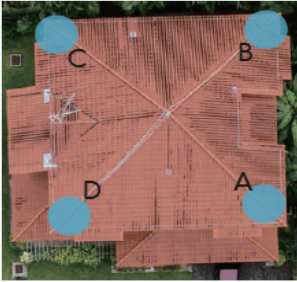

### Step 3: Install the outdoor antenna

#### 3.1 Connect the booster with outdoor antenna.

- (1) Put the booster near to the location you would like to install in the future, or a place with power outlet temporarily.
- (2) Power on the booster and make sure the signal supervisor app links with it smoothly.
- (3) Connect the 16.4ft cable with the booster's outdoor port. The booster supports hot plug.
- (4) Then connect the window cable with 16.4ft cable and pull the window cable outside and connect it with 49.2ft cable. In case window cable is not needed, connect the 16.4ft cable with 49.2ft cable directly.
- (5) Connect the other side of 49.2ft cable with the outdoor antenna.

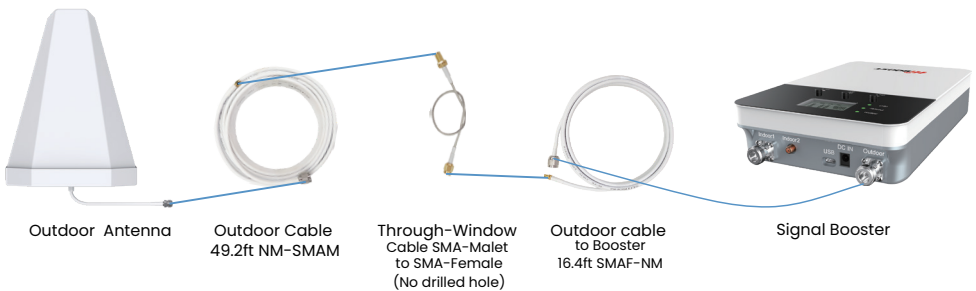

#### Notes:

\*Please do NOT connect indoor antenna at this moment as it will influence the outside signal finding.

\*Please place the booster within 30ft to the possible installation location of outdoor antenna. If Bluetooth connection is applied. This is to ensure the App can connect to the booster.

### 3.2 Look for the best location and direction of outdoor antenna

Now pick up the outdoor antenna and point to above cell tower and adjust its position precisely, ask your partner to watch the LCD signal gauge to get a strongest possible output signal.

Ask your partner to observe the signal meter value, 10dBm (for 4k) or 12dBm (for 10k) is the best.

Notes: The output power level in the signal meter is the level for each of the two indoor

**Fix the outdoor antenna direction when you get the best output power**

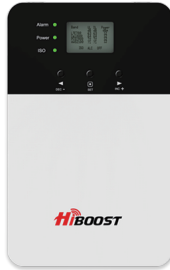

LCD signal meter tells how strong the signal is

Band	UL	DL	POWER
LTE700	dB	dB	dBm
Ce11800	63	63	12
PCS1900	64	64	12
PCS1900	65	65	12
AWS2100	65	65	12
ISO	ALC	OFF	

#### Professional Tips

- Keep in mind that it is normal for the output values may vary dynamically between 1-3 dB
- To optimize the signal for one carrier, point the outdoor antenna towards the closest cell phone tower designated to that carrier
- To optimize the signal for more than one carrier, point the outdoor antenna between multiple towers
- Make sure to slowly turn the antenna while taking the readings so the booster has time to adjust the reading
- Test and install the antenna at the same height where power outputs and gain values reach the booster's maximum capacity
- If you can't get a good output power, for instance, the value is below POOR level, it is highly likely that the installation will fail. Please either find a new place with better signal or drop the installation.

### 3.3 Fix outdoor antenna

Now install the outdoor antenna firmly

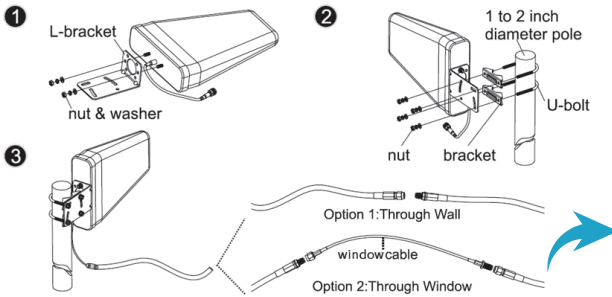

The connector of the cable connection part is glued with black waterproof tape to prevent long-term signal drop and reduce signal loss!



### 3.4 Reconfirm that the signal on LCD signal meter is the best!

And take photo of LCD signal meter for future comparison during indoor antenna install. The thing you need to pay attention here are the gain values. If you have interference between your indoor and outdoor antennas, then the booster will lower the gain and these values will decrease.

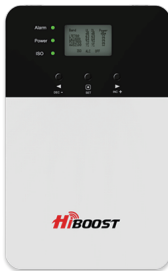

LCD signal meter tells how strong the signal is

Band	UL	DL	Power
LTE700	dB	dB	dBm
Ce11800	63	63	12
PCS1900	64	64	12
PCS1900	65	65	12
ANS2100	65	65	12
ISO	ALC	OFF	

## Step 4: Install the indoor antennas

### 4.1 Install the booster and the cables

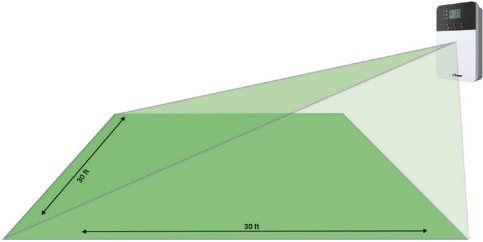

Since there's a built-in indoor antenna in 4K/10K Plus Pro, the booster shall be installed as a panel antenna. Please have your booster pointed to the area you would like to cover with signal.

### 4.2 Signal quality test

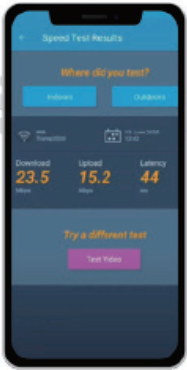

You could do the following:

- (1) First make sure the signal gauge value is unchanged from that during the outdoor antenna installation.
- (2) Do speed tests with the booster on and off, and make a comparison.
- (3) Check if the number of signal bars increases.
- (4) Make a phone call or send messages and check if the voice and streaming are better.

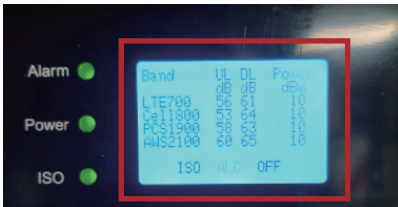
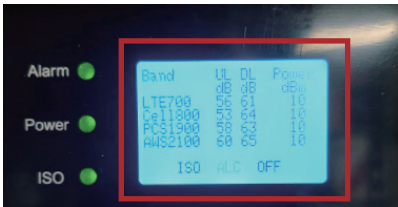

Please skip to Step5 if you use 4k/10k plus.

#### 4.3 Connect the indoor antenna with the booster(For 4k/10k plus pro)

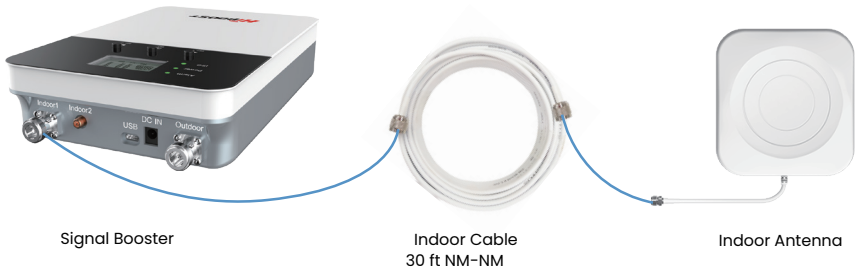

#### 4.4 Adjust the indoor panel antenna

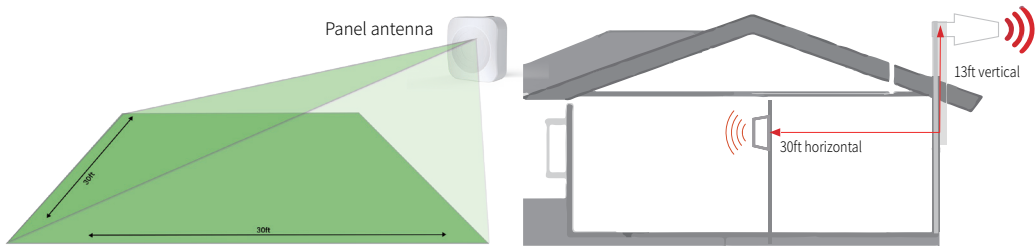

Have your indoor antenna pointed to the area you would like to cover with signal.

#### Notes:

- (1) It would be best if you could make the outdoor antenna and the two indoor antennas face opposite directions.
- (2) For 4K Plus Pro, please make sure the gain reaches about 60dB. If not, please adjust the direction of the indoor antenna/increase the vertical and horizontal distance between the two antennas/add some barriers.
- (3) For 10K Plus Pro, please make sure the gain reaches about 65dB. If not, please adjust the direction of the indoor antenna/increase the vertical and horizontal distance between the two antennas/add some barriers.

## 4.5 Signal Quality test

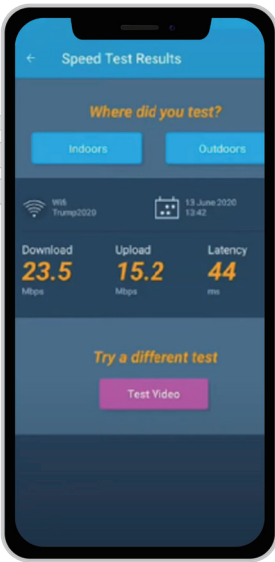

You could do the following:

- (1) First make sure the signal gauge value is unchanged from that during the outdoor antenna installation.
- (2) Do speed tests with the booster on and off, and make a comparison.
- (3) Check if the number of signal bars increases.
- (4) Make a phone call or send messages and check if the voice and streaming are better.

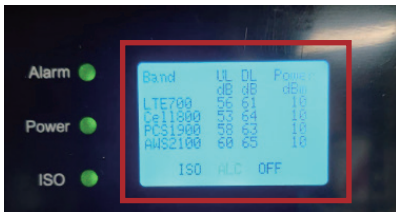

=

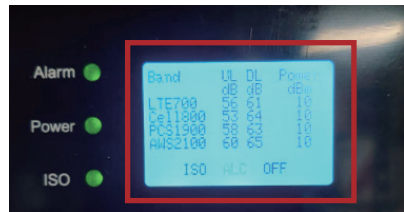

If the test is good, then congratulations, the indoor antenna position has been successfully found. Please install the panel antenna.

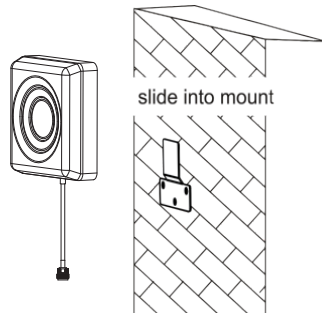
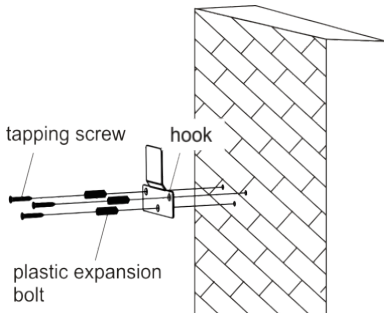

#### 4.6 Use an extra panel antenna(optional)

If the built-in antenna is far away from the area you would like to cover with signal due to the location of power source, you could buy an extra indoor antenna kit. And follow Step 4.3-4.5 to install the antenna again.

Note:

- (1) The built-in antenna will be disabled when the indoor2 port is occupied.
- (2) The connector of indoor2 port is SMA-Female, please make sure you buy the right cable.

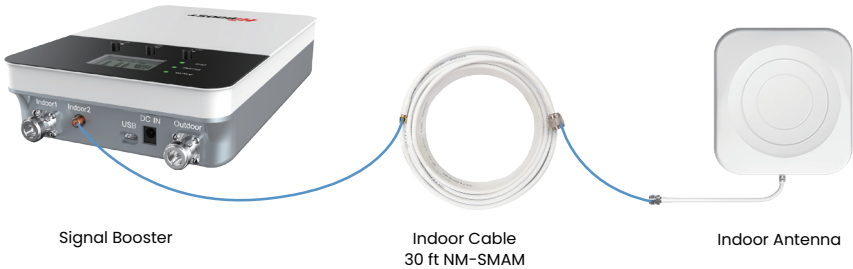

### Step 5: Install the booster and the cables

Mount the signal booster in a dry and cool area, and it shall be easily accessible for maintenance.

And run the cables neatly, please do use the **water-proof tape** to protect all outside connections from the weather.

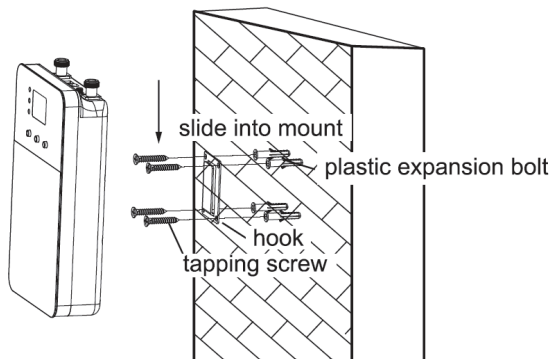



**Test again the performance after installation is done**

- a. First make sure the LCD gauge value is unchanged from the outdoor antenna install.
- b. Test by a third-party app, calls and network data are smooth in most indoor signal coverage areas.

Now everything is completed and please start to enjoy the mobile services.

If the result is not satisfactory or you want to be better, you may repeat the whole or part of the process to improve.

Should you have any queries during the installation, please kindly contact us via Signal Supervisor App online support.

Band	UL	DL	POWER
	dB	dB	dBm
LTE700	63	63	12
Cel1100	64	64	12
FCS1900	65	65	12
AMS2100	65	65	12
ISO	ALC	OFF	

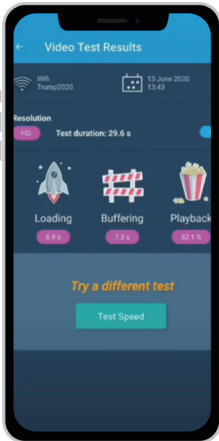

# Quick Troubleshooting Guide

If the booster is working normally, no further adjustment is required

## 4k Plus / 4k Plus Pro

OVERLOAD					
	DL GAIN	OUTPUT POWER	LED LIGHT PATTERN	REASON	SOLUTION
LTE700	<60dB	>=8dBm	Alarm light flashing and Power light solid red	Outdoor signal is too strong	Have your outdoor antenna pointed slightly away from the cell tower
CELL800	<60dB	>=8dBm			
PCS1900	<60dB	>=8dBm			
AWS2100	<60dB	>=8dBm			

LOOP BACK					
	DL GAIN	OUTPUT POWER	LED LIGHT PATTERN	REASON	SOLUTION
LTE700	<60dB	<8dBm	Alarm light flashing and Power light solid red (strong loop back) or green (slight loop back)	Inadequate separation of the indoor and outdoor antennas	<ol style="list-style-type: none"> <li>1. Increase vertical and horizontal distance between the outdoor and indoor antenna(s).</li> <li>2. Make the outdoor antenna and the indoor antenna back to back.</li> <li>3. Add barriers (e.g. walls)</li> </ol>
CELL800	<60dB	<8dBm			
PCS1900	<60dB	<8dBm			
AWS2100	<60dB	<8dBm			

POOR SIGNAL					
	DL GAIN	OUTPUT POWER	LED LIGHT PATTERN	REASON	SOLUTION
LTE700	>=60dB	-/NEGATIVE	Alarm light OFF and power light solid green	Input signal is too weak	<ol style="list-style-type: none"> <li>1. Try adjusting the outdoor antenna to the best direction</li> <li>2. Try adjusting the outdoor antenna to another cell tower</li> <li>3. Try increasing the height of the outdoor antenna and make sure there are no barriers between the tower and the outdoor antenna</li> </ol> Please try these solutions until the output power reaches or is over -5dBm.
CELL800	>=60dB	-/NEGATIVE			
PCS1900	>=60dB	-/NEGATIVE			
AWS2100	>=60dB	-/NEGATIVE			

Normal but No Boosted Signal					
	DL GAIN	OUTPUT POWER	LED LIGHT PATTERN	REASON	SOLUTION
LTE700	>=60dB	>=-5dBm	Alarm light OFF and power light solid green	1. The band is not supported 2. The Signal is from other Carriers	Check the band you are using again. If it stays at band66, get into the 'detail'/ 'Setting' of gagues on Signal Supervisor and switch off RF switch of AWS2100, then adjust the outdoor antenna again. It would be better if there are two persons and one can stay near the indoor antenna to check if the signal is boosted.
CELL800	>=60dB	>=-5dBm			
PCS1900	>=60dB	>=-5dBm			
AWS2100	>=60dB	>=-5dBm			

NORMAL					
	DL GAIN	OUTPUT POWER	LED LIGHT PATTERN	REASON	SOLUTION
LTE700	>=60dB	>=-5dBm	Alarm light OFF and power light solid green		
CELL800	>=60dB	>=-5dBm			
PCS1900	>=60dB	>=-5dBm			
AWS2100	>=60dB	>=-5dBm			

### 10k Plus / 10k Plus Pro

OVERLOAD					
	DL GAIN	OUTPUT POWER	LED LIGHT PATTERN	REASON	SOLUTION
LTE700	<60dB	>=10dBm	Alarm light flashing and Power light solid red	Outdoor signal is too strong	Have your outdoor antenna pointed slightly away from the cell tower
CELL800	<60dB	>=10dBm			
PCS1900	<65dB	>=10dBm			
AWS2100	<65dB	>=10dBm			

LOOP BACK					
	DL GAIN	OUTPUT POWER	LED LIGHT PATTERN	REASON	SOLUTION
LTE700	<60dB	<10dBm	Alarm light flashing and Power light solid red(strong loop back) or green(slight loop back)	Inadequate separation of the indoor and outdoor antennas	1. Increase vertical and horizontal distance between the outdoor and indoor antenna(s). 2. Make the outdoor antenna and the indoor antenna back to back.
CELL800	<60dB	<10dBm			
PCS1900	<65dB	<10dBm			
AWS2100	<65dB	<10dBm			

POOR SIGNAL					
	DL GAIN	OUTPUT POWER	LED LIGHT PATTERN	REASON	SOLUTION
LTE700	>=60dB	--/NEGATIVE	Alarm light OFF and power light solid green	Input signal is too weak	1. Try adjusting the outdoor antenna to the best direction 2. Try adjusting the outdoor antenna to another cell tower 3. Try increasing the height of the outdoor antenna and make sure there are no barriers between the tower and the outdoor antenna Please try these solutions until the output power reaches or is over -5dBm.
CELL800	>=60dB	--/NEGATIVE			
PCS1900	>=65dB	--/NEGATIVE			
AWS2100	>=65dB	--/NEGATIVE			

Normal but No Boosted Signal					
	DL GAIN	OUTPUT POWER	LED LIGHT PATTERN	REASON	SOLUTION
LTE700	>=60dB	>=-5dBm	Alarm light OFF and power light solid green	1. The band is not supported 2. The Signal is from other Carriers	Check the band you are using again. If it stays at band66, get into the 'detail'/ 'Setting' of gages on Signal Supervisor and switch off RF switch of AWS2100, then adjust the outdoor antenna again. It would be better if there are two persons and one can stay near the indoor antenna to check if the signal is boosted.
CELL800	>=60dB	>=-5dBm			
PCS1900	>=65dB	>=-5dBm			
AWS2100	>=65dB	>=-5dBm			

NORMAL					
	DL GAIN	OUTPUT POWER	LED LIGHT PATTERN	REASON	SOLUTION
LTE700	>=60dB	>=-5dBm	Alarm light OFF and power light solid green		
CELL800	>=60dB	>=-5dBm			
PCS1900	>=65dB	>=-5dBm			
AWS2100	>=65dB	>=-5dBm			

**Note:**

Some customers have some misunderstandings about boosters, and we would like to clarify it here:

If you can't even get a stable 1 bar outside the house or on the roof, then we suggest you return it as it won't work in areas with very weak signal, the same is true of all boosters on the market.

# Technical Specifications

Model No.	4K Plus	4K Plus Pro	10K Plus	10K Plus Pro
Working Band	Band 12-17 / Band 13 / Band 5 / Band 25-2 / Band 4			
UL Frequency Range(MHz)	698-716 / 776 – 787 / 824-849 / 1850-1915 / 1710-1755			
DL Frequency Range(MHz)	728-746 / 746 – 757 / 869-894 / 1930-1995 / 2110-2155			
Supported Standards	CDMA, WCDMA, GSM, EDGE, HSPA+, EVDO, LTE ,5G and all cellular standards			
Max. Gain	65 dB		68 dB	
Max. output power	DL 10 dBm		DL 12 dBm	
MGC (Step Attenuation )	≥ 25 dB / 1 dB step			
I/O Port	N-Female & SMA-Female			
Impedance	50 ohm			
Environment Conditions	IP40			
Dimensions	6*9.7*1.4 in / 152*246*36mm			
Weight	≤ 5.0 lbs / 2 kg			
Power Supply	Input AC100–240 V, 50/60 Hz, Output DC 12 V / 3 A			

# Authorized Accessories List

## Outdoor Antenna & Cable Kit Options

### Kit 9-5050

Yagi 9dbi Antenna & 50' 5D Cable

### Kit 11-100400

Yagi 11dbi Antenna & 100' 400 Cable

### Kit 11-7550

Yagi 11dbi Antenna & 75' 5D Cable

### Kit 11-100500

Yagi 11dbi Antenna & 100' 5D Cable

### Kit 10-3050

Panel 10dbi Antenna & 30' 5D Cable

### Kit 10-50400

Panel 10dbi Antenna & 50' 400 Cable

### Kit 10-5050

Panel 10dbi Antenna & 50' 5D Cable

### Kit 10-75400

Panel 10dbi Antenna & 75' 400 Cable

### Kit 10-100400

Panel 10dbi Antenna & 100' 400 Cable

### Kit 10-7550

Panel 10dbi Antenna & 75' 5D Cable

### Kit 10-10050

Panel 10dbi Antenna & 100' 5D Cable

### Kit 9-50400

Yagi 9dbi Antenna & 50' 400 Cable

### Kit 9-75400

Yagi 9dbi Antenna & 75' 400 Cable

### Kit 9-100400

Yagi 9dbi Antenna & 100' 400 Cable

### Kit 9-7550

Yagi 9dbi Antenna & 75' 5D Cable

### Kit 9-10050

Yagi 9dbi Antenna & 100' 5D Cable

### Kit 7-3050

Panel 7dbi Antenna & 30' 5D Cable

### Kit 7-50400

Panel 7dbi Antenna & 50' 400 Cable

### Kit 7-5050

Panel 7dbi Antenna & 50' 5D Cable

### Kit 7-75400

Panel 7dbi Antenna & 75' 400 Cable

### Kit 7-100400

Panel 7dbi Antenna & 100' 400 Cable

### Kit 7-7550

Panel 7dbi Antenna & 75' 5D Cable

### Kit 7-10050

Panel 7dbi Antenna & 100' 5D Cable

### Kit 5-30400

Omni 5dbi Antenna & 30' 400 Cable

### Kit 5-3050

Omni 5dbi Antenna & 30' 5D Cable

### Kit 5-50400

Omni 5dbi Antenna & 50' 400 Cable

### Kit 5-5050

Omni 5dbi Antenna & 50' 5D Cable

### Kit 5-75400

Omni 5dbi Antenna & 75' 400 Cable

### Kit 5-10400

Omni 5dbi Antenna & 100' 400 Cable

### Kit 5-7550

Omni 5dbi Antenna & 75' 5D Cable

### Kit 5-10050

Omni 5dbi Antenna & 100' 5D Cable

## Indoor Antenna & Cable Kit Options

### Kit 72-5050-50

2 Panel 7dbi Antenna with 50' 5D N male  
& 2-Way Splitter

### Kit 52-5050-50

2 Whip 5dbi Antenna & 50' 5D Cable  
& 2-Way Splitter

### Kit 102-5050-50

2 Panel 10dbi Antenna with 50' 5D N male  
& 2-Way Splitter

### Kit 103-7550-50

3 Panel 10dbi Antenna & 75' 5D Cable  
& 3-Way Splitter

### Kit 104-7550-50

4 Panel 10dbi Antenna & 75' 5D Cable  
& 3 2-Way Splitter

### Kit 73-7550-50

3 Panel 7dbi Antenna & 75' 5D Cable  
& 3-Way Splitter

### Kit 74-7550-50

4 Panel 7dbi Antenna & 75' 5D Cable  
& 3 2-Way Splitter

### Kit 3-30400

Omni 3dBi Antenna with 30' 400 Cable

### Kit 3-5050

Omni 3dBi Antenna & 50' 5D Cable

### Kit 3-7550

Omni 3dBi Antenna & 75' 5D Cable

### Kit 3-10050

Omni 3dBi Antenna & 100' 5D Cable

### Kit 3-30400

Omni 3dBi Antenna with 30' 400 Cable

### Kit 3-50400

Omni 3dBi Antenna & 50' 400 Cable

### Kit 32-50400-50

20mni 3dBi Antenna & 50' 400 Cable  
& 2-Way Splitter

### Kit 33-50400-50

3 Omni 3dBi Antenna & 50' 400 Cable  
& 3-Way Splitter

### Kit 34-50400-50

4 Omni 3dBi Antenna & 50' 400 Cable  
& 3 2-Way Splitter

**Notes:** Unauthorized use of accessories (power supplies, antennas, cables, etc.) is strictly prohibited.

# FCC and IC Statements

## **FCC RF EXPOSURE STATEMENT**

This equipment complies with FCC radiation exposure limits set forth for an uncontrolled environment. End users must follow the specific operating instruction for satisfying RF exposure compliance. This transmitter must not be colocated or operating in conjunction with any other antenna or transmitte.

## **IC RF EXPOSURE STATEMENT**

The devices is compliance with RF exposure limits. The minimum distance from body to use the device is 20 CM.

Le présent appareil est conforme aux conformité ou aux limites d'intensité de champ RF. La distance minimale du corps à utiliser le dispositif est de 20 CM.

This equipment has been tested and found to comply with the limits for a Class B digital device, pursuant to part 15 of the FCC Rules. These limits are designed to provide reasonable protection against harmful interference in a residential installation. This equipment generates, uses and can radiate radio frequency energy and, if not installed and used in accordance with the instructions, may cause harmful interference to radio communications. However, there is no guarantee that interference will not occur in a particular installation. If this equipment does cause harmful interference to radio or television reception, which can be determined by turning the equipment off and on, the user is encouraged to try to correct the interference by one or more of the following measures:

- Re-orient or relocate the receiving antenna.
- Increase the separation between the equipment and receiver
- Connect the equipment into an outlet on a circuit different from that to which the receiver is connected
- Consult the dealer or an experienced radio/TV technician for help

Changes or modifications not expressly approved by HiBoost could void the user's authority to operate the equipment. For a complete list of antennas and cables approved for use with these boosters see Authorized Kitting Options

**FCC 27.50(d)(4) Statement:** Fixed, mobile, and portable (handheld) stations operating in the 1710-1755 MHz band are limited to 1-watt EIRP. Fixed stations operating in the 1710-1755 MHz band are limited to a maximum antenna height of 10 meters above ground.

**FURTHER INFORMATION ON SIGNAL BOOSTER END-USE REGISTRATION**

The following links are the currently active contacts for booster registration with U.S. wireless providers:

- <https://www.uscellular.com/uscellular/support/fcc-booster-registration.jsp>
- [https://www.sprint.com/legal/fcc\\_boosters.html](https://www.sprint.com/legal/fcc_boosters.html)
- <https://www.verizonwireless.com/solutions-and-services/accessories/register-signal-booster/>
- <https://support.t-mobile.com/docs/DOC-9827>
- <https://securec45.securewebsession.com/attsignalbooster.com/>

**IC Statement:** This device complies with Innovation, Science and Economic Development Canada ICES-003 Compliance Label: CAN ICES-3 (B)/NMB-3(B). Le présent appareil est conforme Innovation, science et développement économique Canada ICES-003 Étiquette de conformité: CAN ICES-3 (B) / NMB-3 (B).

Please follow the link to access the CPC-2-1-05:

This is a CONSUMER device.

**BEFORE USE**, you **MUST REGISTER THIS DEVICE** with your wireless provider and have your provider’s consent. Most wireless providers consent to the use of signal boosters. Some providers may not consent to the use of this device on their network.If you are unsure, contact your provider.

In Canada, **BEFORE USE**, you must meet all requirements set out in ISED CPC-2-1-05.

You **MUST** operate this device with approved antennas and cables as specified by the manufacturer. Antennas **MUST** be installed least 20 cm(8 inches)from(i. e..**MUST NOT** be installed within 20 cm of)any person.

You **MUST** cease operating this device immediately if requested by the FCC(or ISED in Canada)or a licensed wireless service provider.

**WARNING.** E911 location information may not be provided or may be inaccurate for calls served by using this device.

This device may be operated **ONLY** in a fixed location(i.e., may operate in a fixed location only )for in-building use.



**This is a CONSUMER device.**

**BEFORE USE**, you **MUST REGISTER THIS DEVICE** with your wireless provider and have your provider's consent. Most wireless providers consent to the use of signal boosters. Some providers may not consent to the use of this device on their network. If you are unsure, contact your provider.

In Canada, **BEFORE USE**, you must meet all requirements set out in ISED CPC-2-1-05.

You **MUST** operate this device with approved antennas and cables as specified by the manufacturer. Antennas **MUST** be installed least 20 cm (8 inches) from (i. e., **MUST NOT** be installed within 20 cm of) any person.

You **MUST** cease operating this device immediately if requested by the FCC (or ISED in Canada) or a licensed wireless service provider.

**WARNING.** E911 location information may not be provided or may be inaccurate for calls served by using this device.

This device may be operated **ONLY** in a fixed location (i.e., may operate in a fixed location only) for in-building use.

# Return and Warranty Policies

**30-Day Money-Back Guarantee:** If for any reason the performance of any product is not acceptable, the product may be returned to the reseller within 30-days with proof of purchase. Please contact the customer support team.

**3-Year Warranty:** Signal boosters and kits are warranted for 3 years. We will repair or replace the unit and will cover the cost of delivery back to consumers located within the continental US and Canada. We will only cover shipping to our office if the booster was delivered to you recently, and was delivered defective. Damage caused by the use of non-company power supplies or other accessories is not covered under warranty.

Customers can choose to return the signal boosters and kits directly to the manufacturer at the purchaser's expense with a dated proof of purchase and a Returned Material Authorization (RMA) number supplied by us. RMA numbers may be obtained by contacting customer support at 972-870- 5666 or support @hiboost.com

This warranty does not apply to any signal boosters or kits determined by us to have been subjected to tampering, misuse, abuse, neglect, or mishandling that alters or damages physical or electronic properties.

We are not liable for any Signal Supervisor application network connectivity issues. The cell phone signal booster relies on a strong, continuous and reliable connection to the internet in order to communicate with the cell phone application. For all Signal Supervisor Application related issues, please check your network strength and call our technical support.

Failure to use a surge-protected AC power strip with at least a 1000 Joule rating will void your warranty. Damage caused by lightning is not covered by this warranty.

All of the products that are packaged with other accessory products are intended for resale and used as a single integrated system. Such product kits are required to be sold to the end-users or subsequent reseller as packaged.

