

User Manual

Home Mobile Signal Booster

4K Smart Link
10K Smart Link
15K Smart Link

3150 Premier Drive, Suite 130,
Irving, TX 75063
(972) 870-5666
service@hiboost.com
www.hiboost.com





CONTENTS

Package Content.....	01
Introduction	04
Pre-Installation Instructions.....	05
APP Assisted Installation	10
LCD Assisted Installation	24
Quick Troubleshooting Guide	37
Technical Specifications.....	39
Authorized Accessories List	40
FCC and IC Statements	41
Return and Warranty Policies	43

Package Content

4K Smart Link



Outdoor Antenna



Outdoor Cable
32.8ft NM-SMAM



Through-Window Cable
SMA-Male to SMA-Female
(No drilled hole)



**Outdoor cable to
Booster**
16.4ft SMAF-NM



Booster



Indoor Cable X1
30ft NM-NM
(for indoor)



Indoor Antenna X1



**Bluetooth and
Wi-Fi antenna**



Power Supply

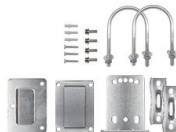

Accessories for main parts
are all provided



3M waterproof tape
to protect connections

Package Content

10K Smart Link



Outdoor Antenna



Outdoor Cable
32.8ft NM-SMAM



Through-Window Cable
SMA-Male to SMA-Female
(No drilled hole)



**Outdoor cable to
Booster**
16.4ft SMAF-NM



Booster



Indoor Cable X1
30ft NM-NM
(for indoor)



Indoor Antenna X1



**Bluetooth and
Wi-Fi antenna**



Power Supply



Accessories for main parts
are all provided



3M waterproof tape
to protect connections

15K Smart Link



Outdoor antenna



50ft Outdoor cable



**Bluetooth and
Wi-Fi antenna**



Booster



50ft Indoor cable



Indoor antenna



Power supply



Other Accessories



3M waterproof tape
to protect connections

NOTE: Available accessories can be purchased through HiBoost.com

Warning: Un-authorized antennas, cables, and/or coupling devices are prohibited by new FCC rules. Please contact FCC for details: 1(888)-CALL-FCC

Introduction

Thanks again for purchasing HiBoost cell phone Booster. The Smart Link series is a collection of precision-engineered products that improve cellular reception inside of homes and businesses by amplifying incoming and outgoing cell phone signals.

HiBoost cell booster's exclusive cloud-based Signal Supervisor mobile application and LCD display allow users to monitor the live status of HiBoost cell phone signal boosters directly from the LCD display or remotely from a mobile device anywhere at any time.

If there are any issues while installing a HiBoost 4K/10K/15K Smart Link Signal cell phone signal booster, please contact the HiBoost technical support team through the following

Online Support: Create a ticket or chat via Signal Supervisor App

 (972) 870-5666 (M-F from 9 am – 5 pm CST)

 service@hiboost.com

 www.hiboost.com

Pre-Installation Instructions

We strongly recommend you to read the user guide completely before beginning the installation.

HiBoost SmartLink booster provide 2 options of booster installation, APP and LCD installation ways are unique methods provided by HiBoost. This installation guide will take the HiBoost 4K SmartLink as an example.

1. App assisted installation, **FIRST CHOICE From Page 09~22.**

It's more convenient and many work could be done by ONE person, and the most important is that the obtained signal can be very precise.



The App helps you find the best signal outside



2. LCD assisted installation, **SECOND CHOICE From Page 23~35.**

It can achieve the same precise effect as App guidance. But it may need two people and the installation process is a little cumbersome.



LCD signal meter tells how strong the signal is

Band	UL	DL	Power
	dB	dB	dBm
LTE700	60	60	10
CE1800	60	60	10
PCS1900	60	60	10
AWS2100	60	60	10
ISO	ALC	OFF	

Then why has HiBoost spent extra big efforts and costs to design APP and LCD signal meters to help you install?

Out of the various reasons, the most important reason is that we would like you, our valuable client, to get the maximum output power from the booster system in order to get optimal signal reception for all your mobile devices.

 As it is known and a big thanks, FCC makes signal boosters legal in 2014 so that every body can install and benefit from the signals;

 But FCC regulations do limit the gain and output power of all consumer boosters to low values in order to avoid any interference to the cell towers;

 Furthermore FCC stipulates that any improper install should trigger immediately further reduction of the booster's already-limited gain and power to protect the towers.

 Therefore, you can understand how important you need to find the perfect outside signal from the tower and how important to squeeze every last gain and power from the booster, even 1dB more power is so precious when you suffer from no signals.

HiBoost App & LCD signal meters will help you to fine tune the best power and get as much cover of your spaces.

General Working Principle:

Before we start any of the two ways, please allow us to spend 3 pages to make you understand how the booster system works for you.

※ Please do spend sometime to read it fully, as it is crucial to get full bars for your rooms.

How HiBoost booster works

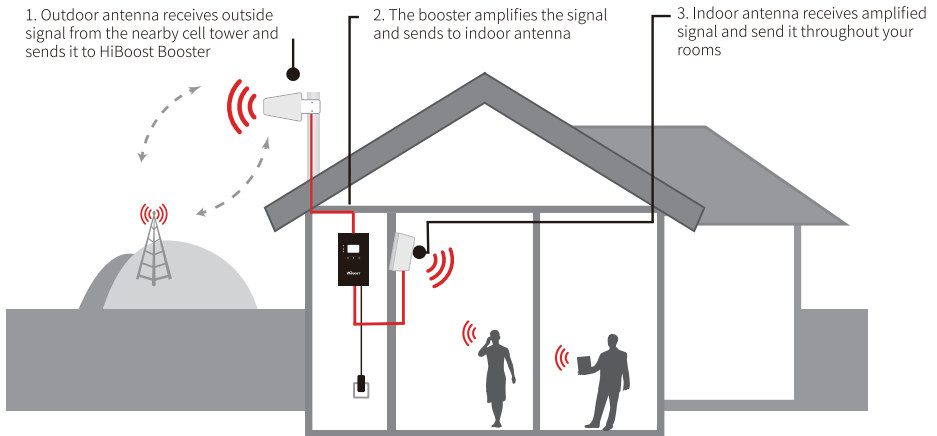

Vice versa, indoor antenna receives cellphone signal and sends to the booster
The booster then amplifies the signal and sends it to outdoor antenna
Outdoor antenna sends signal to the cell tower
Then you can make phone calls and internet streaming.

Working Principle in Formula

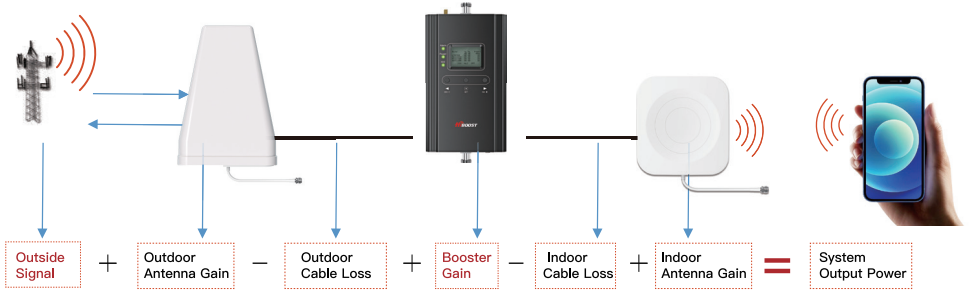

Out of the Formula:

Outside Signal: To be received by outdoor antenna from cell tower

Outdoor Antenna Gain: The gain of outdoor antenna

Outdoor Cable Loss: The loss of the outdoor cable

Booster Gain: The actual working gain of the booster

Indoor Cable Loss: The loss of the indoor cable

Indoor Antenna Gain: The gain of indoor antenna

For example:

-65dBm + 11dBi - 4.5dB + 60dB - 2dB + 7dBi = 6.5dBm (System Output Power)

Since the figures in **Black** color are fixed when you finish the purchase, thus the **RED** figures of

1. Outside Signal

2. Booster Gain will play a vital role in reaching the best output power during the install, especially when we know the FCC limits the booster system values.

So the user guide is focused on:

1. Getting the best outside signal.
2. Keeping the maximum booster gain.

More notes on how to keep the maximum booster gain

The loop back from the outdoor antenna to the indoor antenna will reduce the gain, so the principle to keep the maximum booster gain is to avoid the loop back from the outdoor antenna to the indoor antenna.

1) Increase the distance between the outdoor and indoor antenna, generally the same vertical distance generates more loss than horizontal, and to follow easily, a Typical Required Distance Between Outdoor and Indoor Antenna Over 30 feet (10 meters) horizontal distance or 13 feet (4 meters) vertical distance.

2) The outdoor and indoor antennas shall be back to back.

3) Use barriers between the indoor and outdoor antenna.

※ Please note: This separation is not an absolute mandate. The idea is to isolate the outdoor antenna from the indoor antenna.

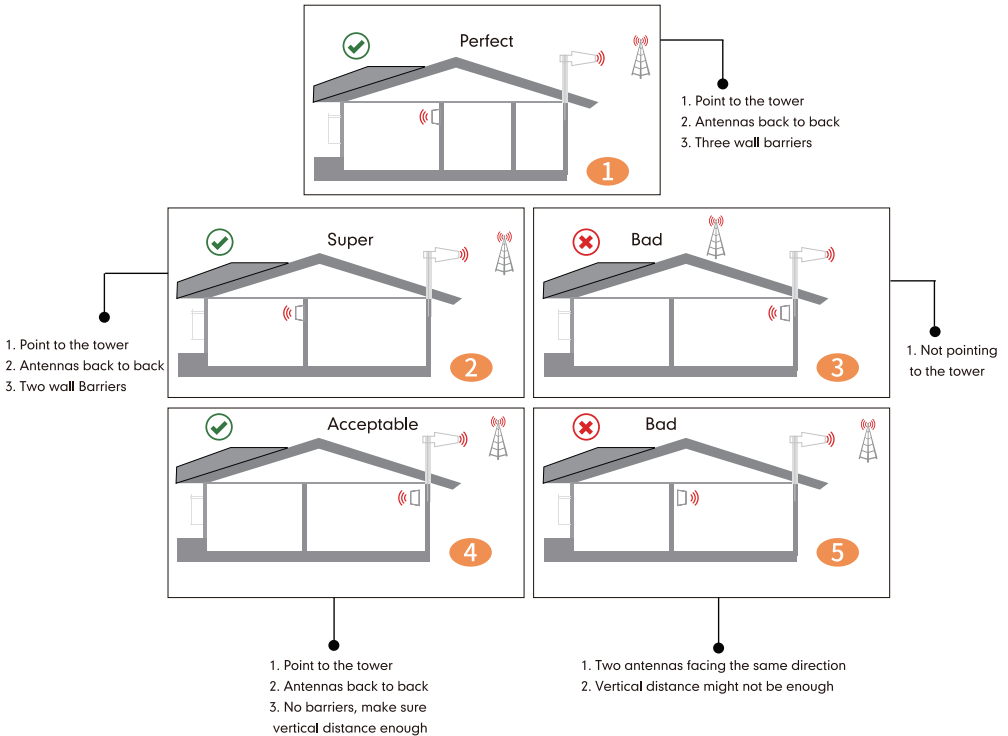

APP Assisted Installation

Flow chart of APP Assisted Installation

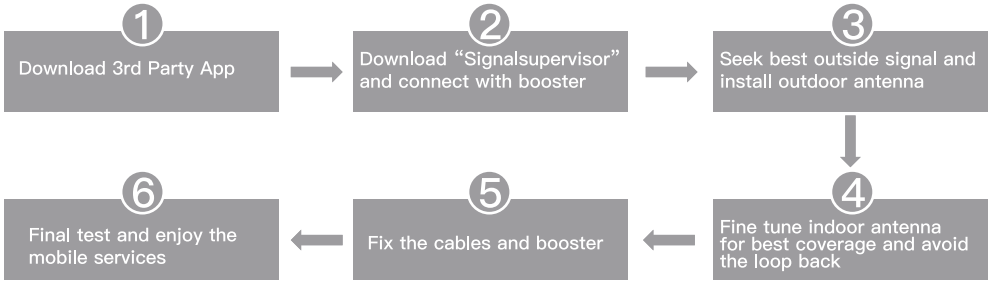

Step 1: Download the 3rd Party Mobile apps

We are going to use 3rd party apps:

- To find the cell tower location
- To test the signal strength and quality

There are a variety of resources available online: Opensignal,Cell mapper, Network cell info lite, etc.

Please download them beforehand over Android and / or iOS:

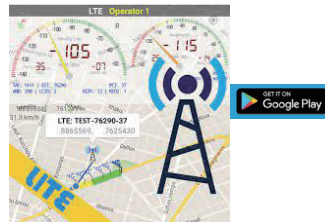

※ You can use either of them to your favor. Here we are using Opensignal and Network Cell Info Lite as first two choices.

Step 2: Download Signal Supervisor app and connect the booster

Download the Signal Supervisor app, register ID and booster.



- 1) Search “Signal Supervisor” on Google Play/ App Store, or scan the above QR Code to download.
 - 2) Register on the Signal Supervisor app.
 - 3) Switch on the booster.
- * Connect the Bluetooth/WiFi antenna with booster, and there is no need to connect outdoor or indoor antenna at this moment.
- 4) Click “Add Device” to register the booster into the APP. And we recommend WiFi connection because the Bluetooth connection can’t go beyond 30ft. Check more steps about the app uses as below.

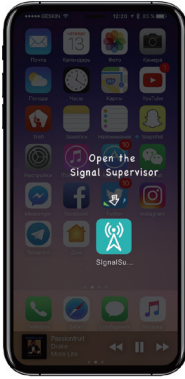

1

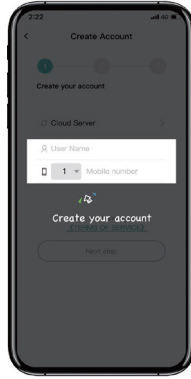

2

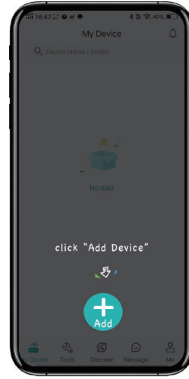

3



4

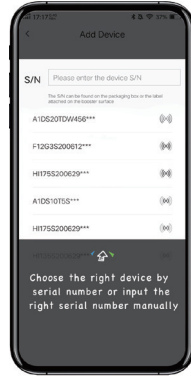

5

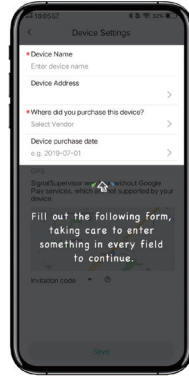

6



7

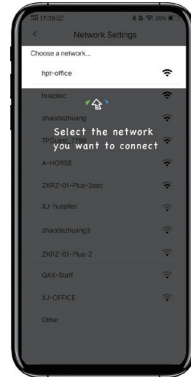

8

Remark: Due to the phone types and the WiFi router types, there are few cases though rare that the booster won't be linked successfully to the signal supervisor app, even after our technical support. In such case:

* Please kindly switch to use LCD signal meter to assist your install and will have the same result. And Bluetooth/WiFi disconnection won't influence the booster working status at all.

* Or please use different phone or change your WiFi router if you really want remote monitor.

Please contact our tech support and we will see what the best arrangements can be for you.

Step 3: Look for best outside signal and install outdoor antenna

The performance of the booster system is heavily dependent on the successful installation of the outdoor antenna

3.1 Connect the booster with outdoor antenna

- (1) Put the booster near to the location you would like to install in the future, or a place with power outlet temporarily.
- (2) Keep the booster connected with Bluetooth/WiFi antenna.
- (3) Switch on the booster and make sure the signal supervisor app links with it smoothly.
- (4) Connect the 16.4ft cable with the booster's outdoor port. The booster supports hot plug.
- (5) Then connect the window cable with 16.4ft cable and pull the window cable outside and connect it with 32.8ft cable. In case window cable is not needed, connect the 16.4ft cable with 32.8ft cable directly.
- (6) Connect the other side of 32.8ft cable with the outdoor antenna.

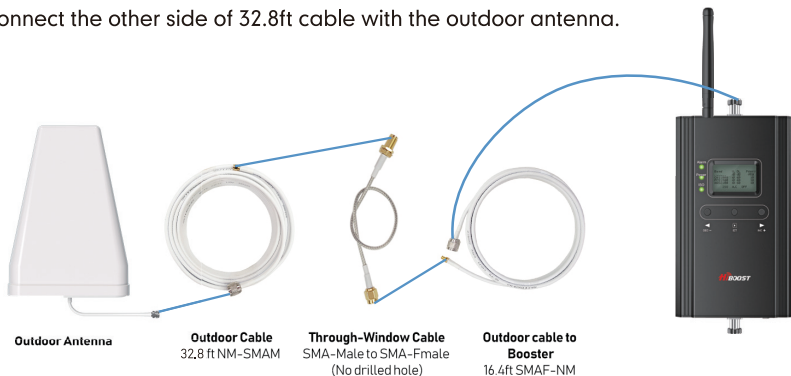

*HiBoost 15K SmartLink can be directly connected to the outdoor antenna with the 50ft NM-NM cable.

Notes:

- * It is a must **NOT** to connect indoor antenna at this moment as it will influence the outside signal finding.
- * Please place the booster outdoor within 30ft to the possible location of outdoor antenna if there is only Bluetooth connection. This is to ensure the App links to the booster.

3.2 Select the possible location for best outside signal.

Bring your mobile phone with the APPs and the outdoor antenna to the location where the best outside signal can be found. The outdoor antenna is recommended to be at the four corners or high end of the roof, or attic.

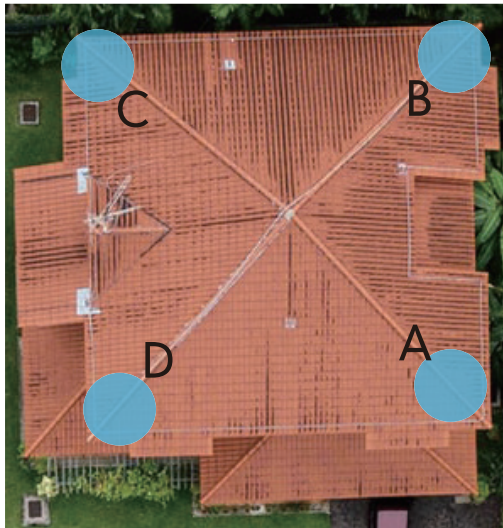

The outdoor antenna needs to maintain a clear line of sight with the cell tower. And it is necessary to avoid the roof or other stuffs from blocking the outdoor antenna.



3.3 Use 3rd party APP to locate the tower(s)

Now open “Opensignal”, use it to detect the approximate position of the nearby cell tower.

(1) Insert your detail address in “Search city” box. (following figure 1)

(2) Enter signal dashboard, and click “CELL TOWERS”. Then zoom in map to find best one, it will show a blue line with your place which means your cellphone connected one. (following figure 2&3)

(3) When you find such location, check the strength, test voice and data speed. A good signal shall not only be strong, but also be clear in voice and fast in data speed. (following figure 4-6)

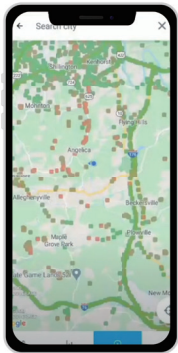

Figure 1

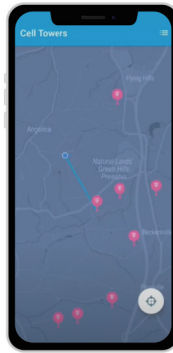

Figure 2

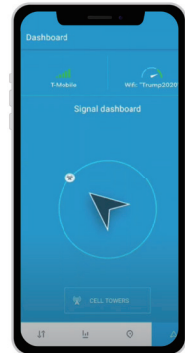

Figure 3

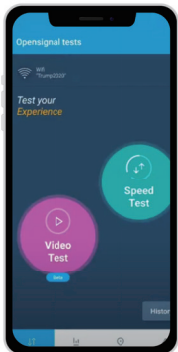

Figure 4

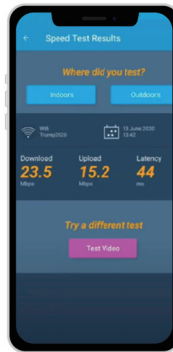

Figure 5

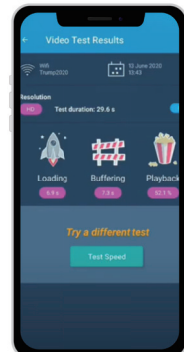
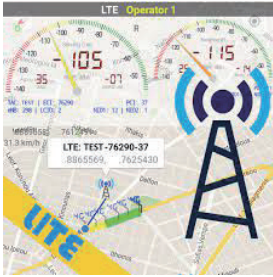

Figure 6

You can also use the “Network Cell Info Lite” to locate the tower and measure the signal strength before & after install.

The good point of Network Cell Info Lite is that you can see the signal levels.

But it seems to be only available for Android.



Network Cell Info Lite



The signal strength requested by the booster system is as below.

SIGNAL STRENGTH	EXCELLENT	GOOD	FAIR	POOR	DEAD ZONE
3G/1X	-70dBm	-70 to -85dBm	-86 to -100dBm	-101 to -109dBm	-101dBm
4G/LTE	-90dBm	-90 to -105dBm	-106 to -110dBm	-111 to -119dBm	-120dBm



Your signal strength is going to be a good indicator of how fast you can download and stream, but for voice, it's more like "Can I make a call, or not?" If you can make a call you should not care how many bars you have, as long as the call goes through and everyone can hear everyone. Looking at bars is just going to make you cranky.



The reason to test your internet speed is to make sure you'll be able to stream high-bandwidth movies, like those from Netflix, Hulu, Amazon, and other providers. If your internet speed is too slow, you'll get choppy video or regular buffering.

3.4 Look for the best location and direction of outdoor antenna

After the tower is located, please pick up outdoor antenna and point to the tower and adjust its direction precisely.

Watch the signal gauge of Signal Supervisor App as it will show the booster's best output power when you get the strongest outside signal.

Target: Try to get the highest possible output power for each band and try to make 2-3 gauges turn green.

1) You can either look at the signal meter value, 10dBm is the best

2) Or you can look at the signal description, Super is the best

Notes: The output power level in the signal meter is the level for the indoor antenna.

Fix the outdoor antenna direction when you get the best output power.

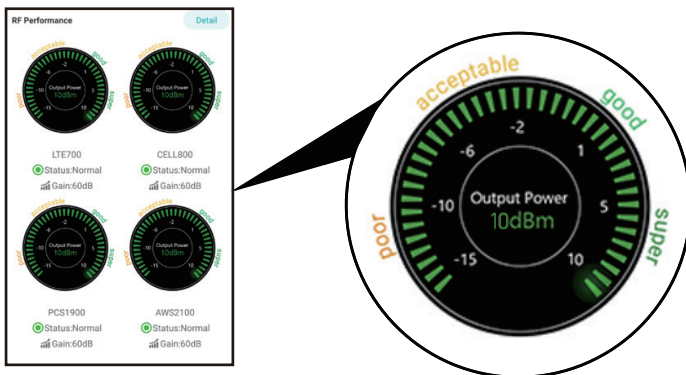

Professional Tips

- Keep in mind that it is normal for the output values may vary dynamically between 1-3 dB
- To optimize the signal for one carrier, point the outdoor antenna towards the closest cell phone tower designated to that carrier
- To optimize the signal for more than one carrier, point the outdoor antenna between multiple towers
- Make sure to slowly turn the antenna while taking the readings so the booster has time to adjust the reading
- Test and install the antenna at the same height where power outputs and gain values reach the booster's maximum capacity
- **If you can't get a good output power, which is even below poor, most probably the install will fail. Either please find a new place to find good signal again, or drop the install.**

3.5 Fix outdoor antenna

Now install the outdoor antenna firmly

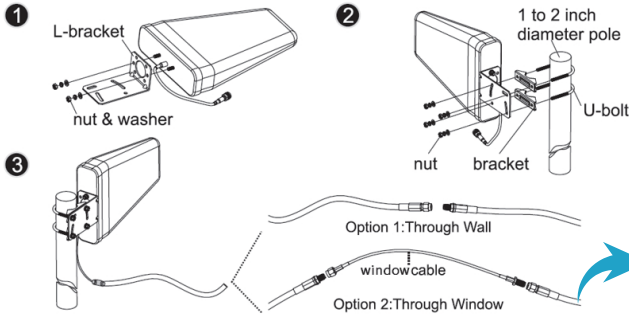

The connector of the cable connection part must be glued with black waterproof tape to prevent long-term signal drop and reduce signal loss!



3.6 Reconfirm that the signal on signal gauge is the best!

Please **do take following screen shot** for future comparison during indoor antenna install.

What you are going to be paying attention to here, is the gain values. If you have interference between your indoor and outdoor antennas, then the booster will lower the gain and these values will decrease.



Step 4: Install the indoor antenna

4.1 Now it's turn to install the indoor antenna

Note: It is better to have two people at this stage. One can go around to find the best place for indoor antenna. While the other can walk around to make tests all over to make sure every spot is covered with stable and high quality signal.

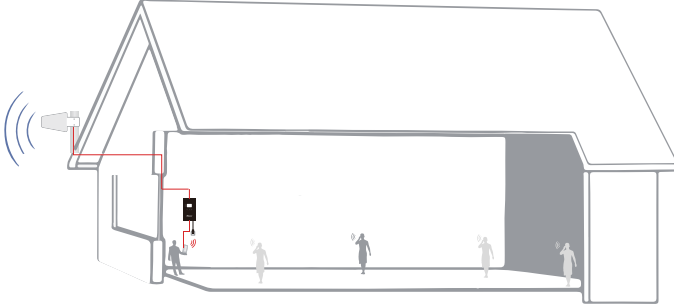

4.2 Connect the indoor antenna with the booster's indoor port by indoor cable, and switch on the booster.

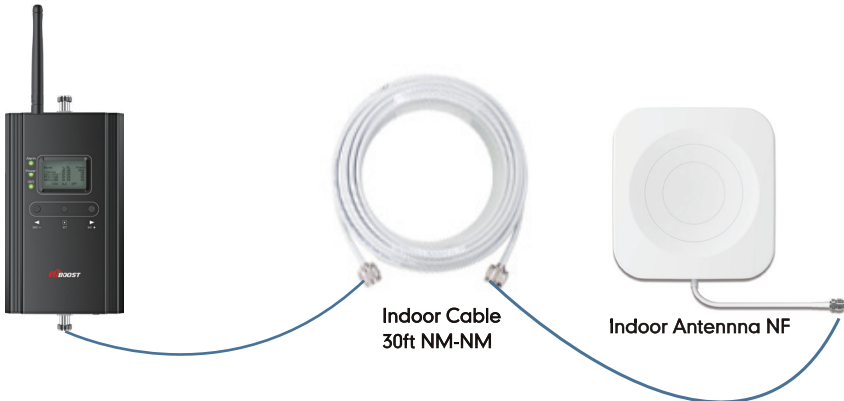

4.3 Find the proper location for indoor antenna

1) Determine the location according to the antenna's radiation pattern. The radiation pattern is 80° horizontal and 70° vertical. So try to make sure the space will fall into its radiation pattern.

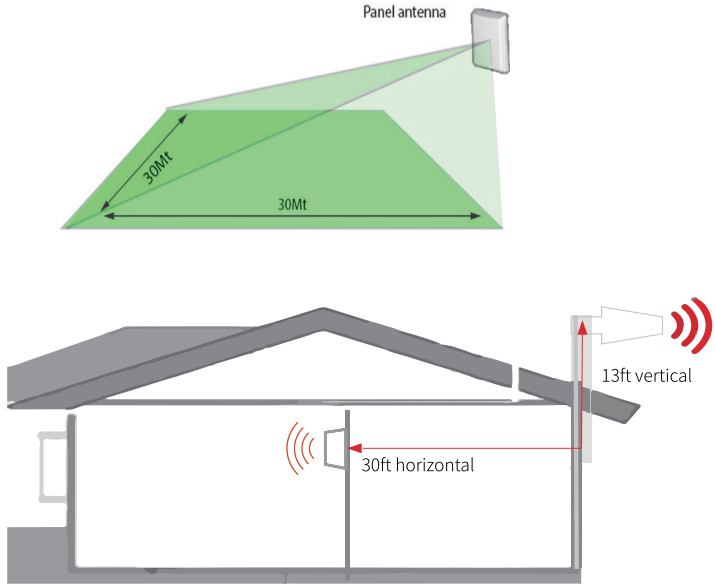

2) After finding the location, hold it there, and watch the gain and power on the App's signal gauge, they shall keep the same or very nearby with the screen shot taken during outdoor antenna install. This is to avoid the loop back between outdoor and indoor antennas, please move the indoor antenna till you get unchanged or slightly changed gain and power. This step is quite crucial for the booster's best performance.

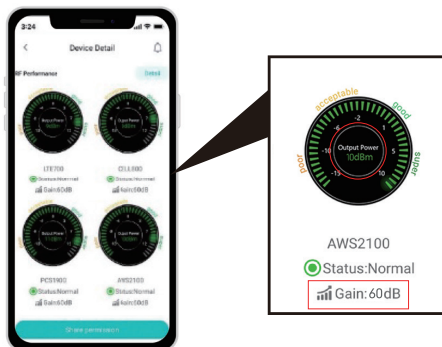

Two requests of indoor antenna install

- A. Radiation shall be good enough to cover whole space
- B. Loop back shall be avoided

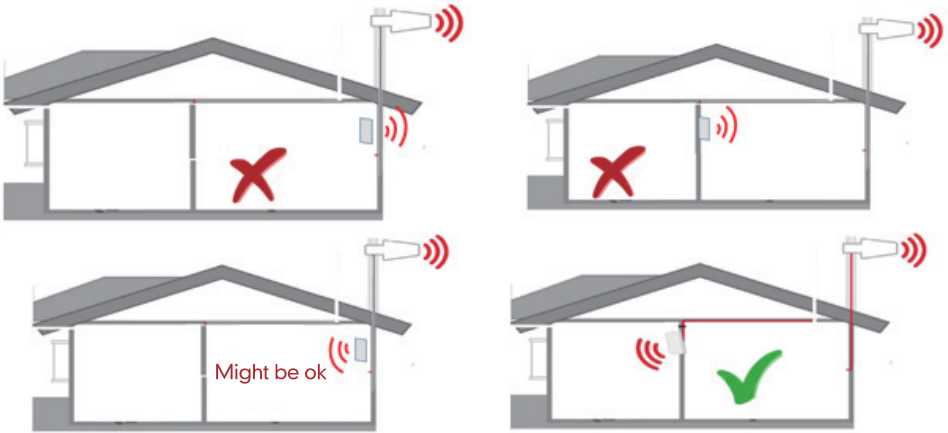

Again the tips to avoid the loop back

1. Increase the distance between the outdoor and indoor antennas
2. The outdoor and indoor antennas shall be back to back
3. Use barriers between the indoor and outdoor antennas

4.4 Signal Quality test

After finding such a location, hold the indoor antenna there and ask the other person to walk back and forth, and use the 3rd party app Network Cell Info Lite & OpenSignal to test the signal strength, voice, and data.

We recommend you to test the signal strength, the voice quality and data speed.

*Notes Again: Just remember that strength and quality are two separate issues. A poor quality “strong” signal can be next to useless, but a clean signal of two bars might be all your device needs.

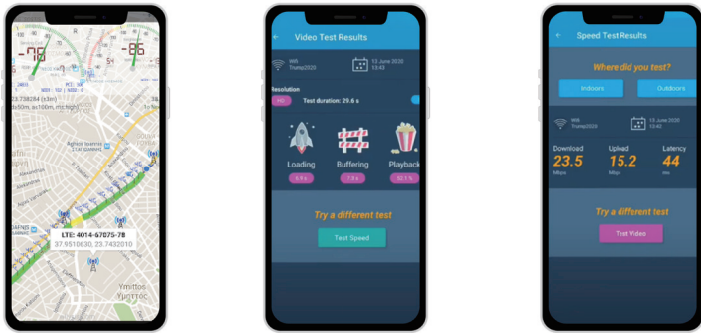

If the test is good, then congratulations, the indoor antenna position has been successfully found. Please install the indoor antenna.

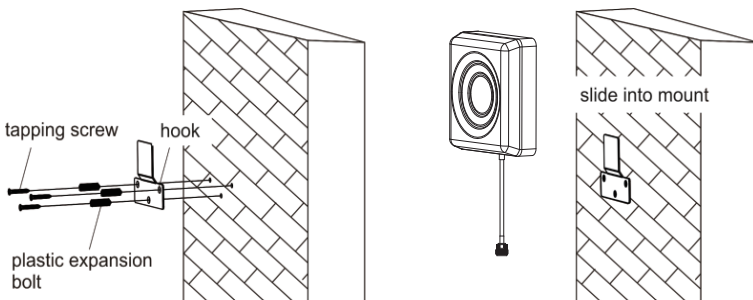

Step 5: Install the booster and the cables

Mount the signal booster in a dry and cool area, and it shall be easily accessible for maintenance.

And run the cables neatly, please do use the **water-proof tape** to protect all outside connections from the weather.

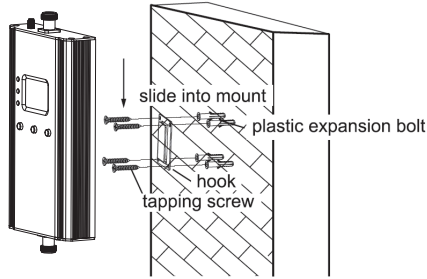

Test again the performance after installation is done

a. First make sure the Signal gauge value is unchanged from the outdoor antenna install.
b. Test by a third-party app, calls and network data are smooth in most indoor signal coverage areas.

a. Now everything is completed and please start to enjoy the mobile services.

b. If the result is not satisfactory or you want to be better, you may repeat the whole or part of the process to improve.

c. Please contact us: Signal Supervisor App online support, Phone and Email in case you have any problems.

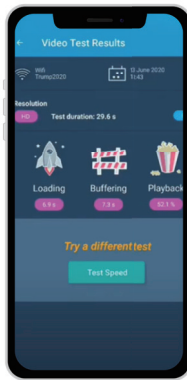
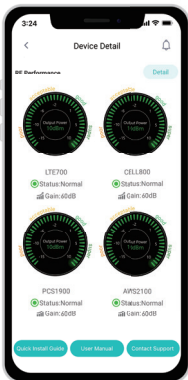

LCD Assisted Installation

Flow chart of LCD Assisted Install



Step 1: Download the 3rd Party Mobile Apps

We are going to use 3rd party APPs:

- To find the cell tower location
- To test the signal strength and quality

There are a variety of resources available online: Opensignal, Cell mapper, Network cell info lite, etc.

Please download them beforehand over Android and / or iOS:

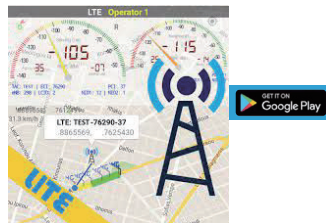

※ You can use either of them to your favor. Here we are using Opensignal and Network Cell Info Lite as first two choices.

Step 2: Install the outdoor antenna

2.1 Connect the booster with outdoor antenna.

- (1) Put the booster near to the location you would like to install in the future, or a place with power outlet temporarily.
- (2) Keep the booster connected with Bluetooth/WiFi antenna.
- (3) Switch on the booster and make sure the signal supervisor app links with it smoothly.
- (4) Connect the 16.4ft cable with the booster's outdoor port. The booster supports hot plug.
- (5) Then connect the window cable with 16.4ft cable and pull the window cable outside and connect it with 32.8ft cable. In case window cable is not needed, connect the 16.4ft cable with 32.8ft cable directly.
- (6) Connect the other side of 32.8ft cable with the outdoor antenna.

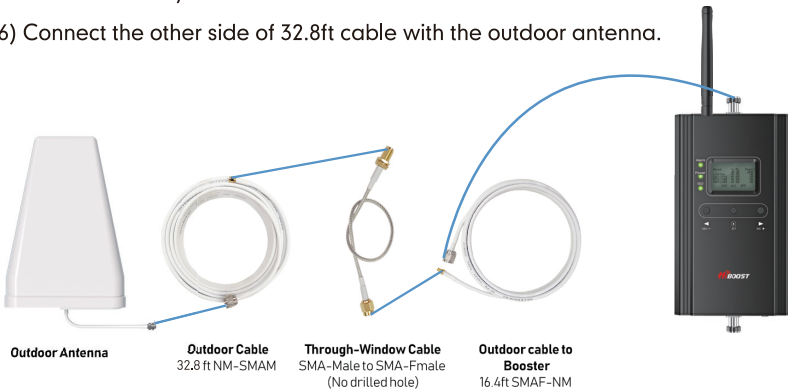

*HiBoost 15K SmartLink can be directly connected to the outdoor antenna with the 50ft NM-NM cable.

Notes:

It is a must **NOT** to connect indoor antenna at this moment as it will influence the outside signal finding.

2.2 Select the possible location for best outside signal.

Bring your mobile phone with the 3rd party APPs and the outdoor antenna to the location where the best outside signal can be found. The outdoor antenna is recommended to be at the four corners or high end of the roof, or attic.

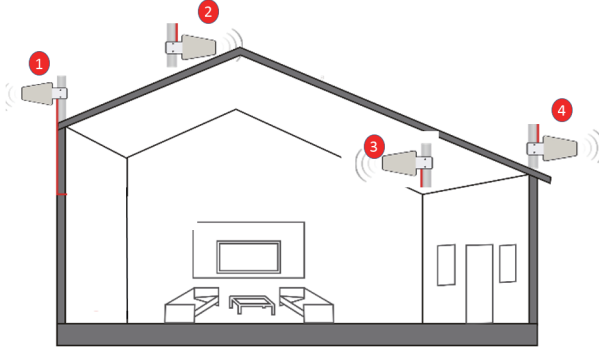

The outdoor antenna needs to maintain a clear line of sight with the cell tower. And it is necessary to avoid the roof or other stuffs from blocking the outdoor antenna.

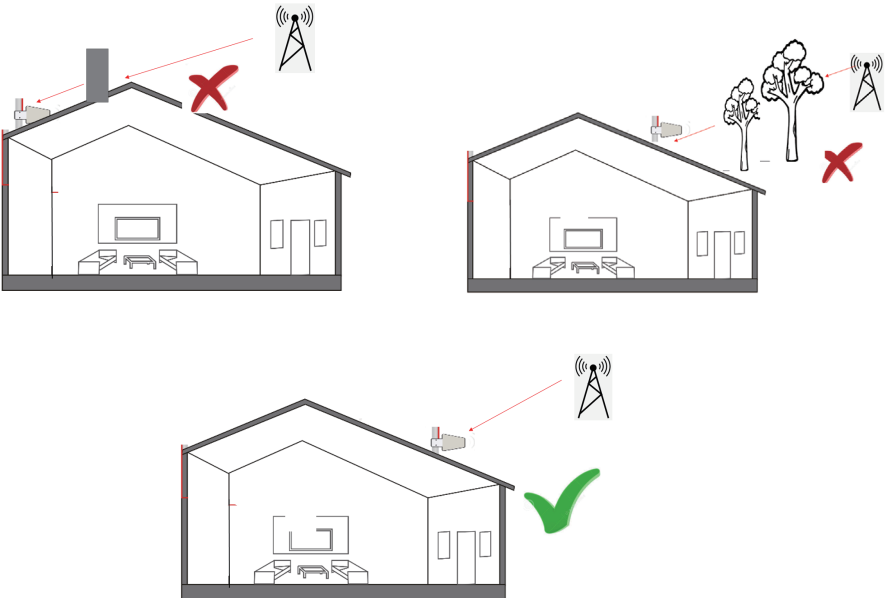

2.3 Use 3rd party APP to locate the tower(s)

- 1) Now open "Opensignal", use it to detect the approximate position of the nearby cell tower.
- 2) Insert your detail address in "Search city" box. (following figure 1)
- 3) Enter signal dashboard, and click "CELL TOWERS". Then zoom in map to find best one, it will show a blue line with your place which means your cellphone connected one. (following figure 2&3)
- 4) When you find such location, check the strength, test voice and data speed. A good signal shall not only be strong, but also be clear in voice and fast in data speed.

Notes:

Just remember that strength and quality are two separate issues. A poor quality "strong" signal can be next to useless, but a clean signal of two bars might be all your device needs.

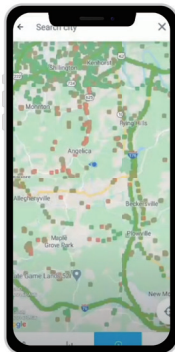

Figure 1

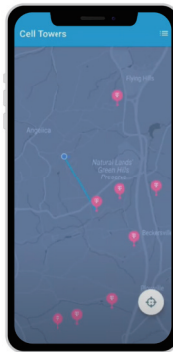

Figure 2

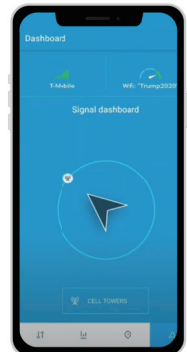

Figure 3

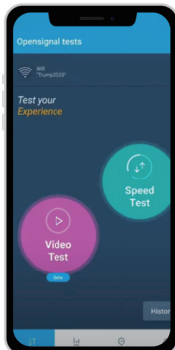

Figure 4

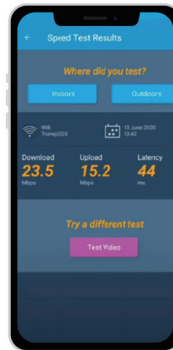

Figure 5

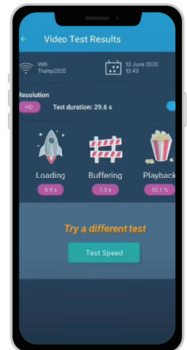

Figure 6

You can also use the “Network Cell Info Lite” to locate the tower and measure the signal strength before & after install.

The good point of Network Cell Info Lite is that you can see the signal levels. But it seems to be only available for Android.



The signal strength requested by the booster system is as below.

SIGNAL STRENGTH	EXCELLENT	GOOD	FAIR	POOR	DEAD ZONE
3G/1X	-70dBm	-70 to -85dBm	-86 to -100dBm	-101 to -109dBm	-101dBm
4G/LTE	-90dBm	-90 to -105dBm	-106 to -110dBm	-111 to -119dBm	-120dBm



Your signal strength is going to be a good indicator of how fast you can download and stream, but for voice, it's more like “Can I make a call, or not?” If you can make a call you should not care how many bars you have, as long as the call goes through and everyone can hear everyone. Looking at bars is just going to make you cranky.



The reason to test your internet speed is to make sure you'll be able to stream high-bandwidth movies, like those from Netflix, Hulu, Amazon, and other providers. If your internet speed is too slow, you'll get choppy video or regular buffering.

2.4 Look for the best location and direction of outdoor antenna

Now pick up the outdoor antenna and point to above cell tower and adjust its position precisely, ask your partner to watch the LCD signal gauge to get a strongest possible output signal.

Ask your partner to look at the signal meter value, 10dBm is the best.

Notes: The output power level in the signal meter is the level for the indoor antenna.

Fix the outdoor antenna direction when you get the best output power



LCD signal meter tells how strong the signal is

Band	UL	DL	Power
LTE700	dB	dB	dBm
Ce11800	60	60	10
PCS1900	60	60	10
AWS2100	60	60	10
ISO	ALC	OFF	

Professional Tips

- Keep in mind that it is normal for the output values may vary dynamically between 1-3 dB
- To optimize the signal for one carrier, point the outdoor antenna towards the closest cell phone tower designated to that carrier
- To optimize the signal for more than one carrier, point the outdoor antenna between multiple towers
- Make sure to slowly turn the antenna while taking the readings so the booster has time to adjust the reading
- Test and install the antenna at the same height where power outputs and gain values reach the booster's maximum capacity
- **if you can't get a good output power, which shows --, most probably the install will fail. Either please find a new place to find good signal again, or drop the install.**

2.5 Fix outdoor antenna

Now install the outdoor antenna firmly

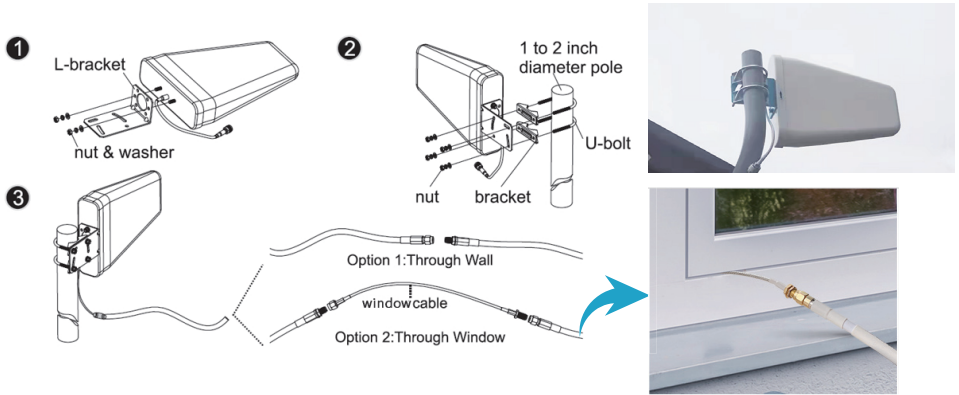

The connector of the cable connection part is glued with black waterproof tape to prevent long-term signal drop and reduce signal loss!



2.6 Reconfirm that the signal on LCD signal meter is the best

And take photo of LCD signal meter for future comparison during indoor antenna install. What you are going to be paying attention to here, is the gain values. If you have interference between your indoor and outdoor antennas, then the booster will lower the gain and these values will decrease.



LCD signal meter tells how strong the signal is

Band	UL	DL	Power
	dB	dB	dBm
LTE700	60	60	10
Ce11300	60	60	10
PCS1900	60	60	10
AWS2100	60	60	10
ISO	ALC	OFF	

Step 3: Install the indoor antenna

3.1 Now it's turn to install the indoor antenna.

Note: It is better to have two people at this stage. One can go around to find the best place for indoor antenna. While the other can walk around to make tests all over to make sure every spot is covered with stable and high quality signal.

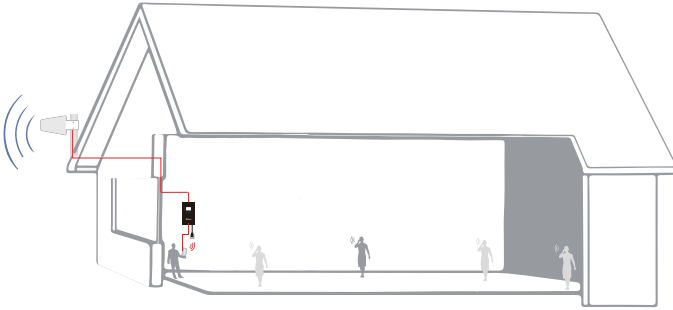

3.2 Connect the indoor antenna with the booster by indoor cable, and switch on the booster.

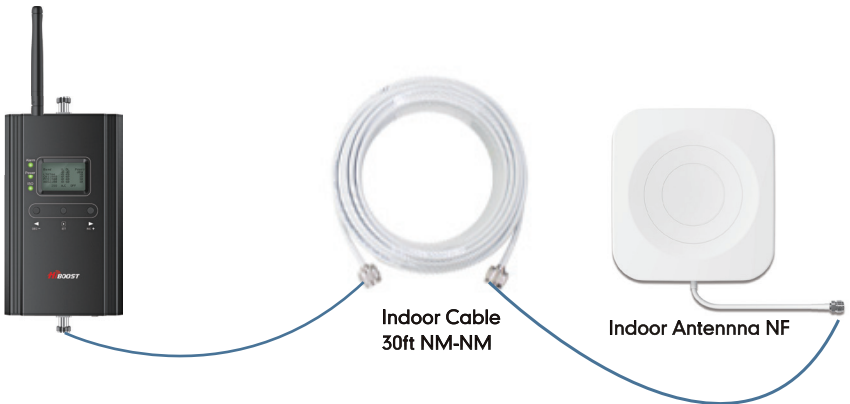

3.3 Find the proper location for indoor antenna

1) Determine the location according to the antenna's radiation pattern. The radiation pattern is 80° horizontal and 70° vertical. So try to make sure the space will fall into its radiation pattern.

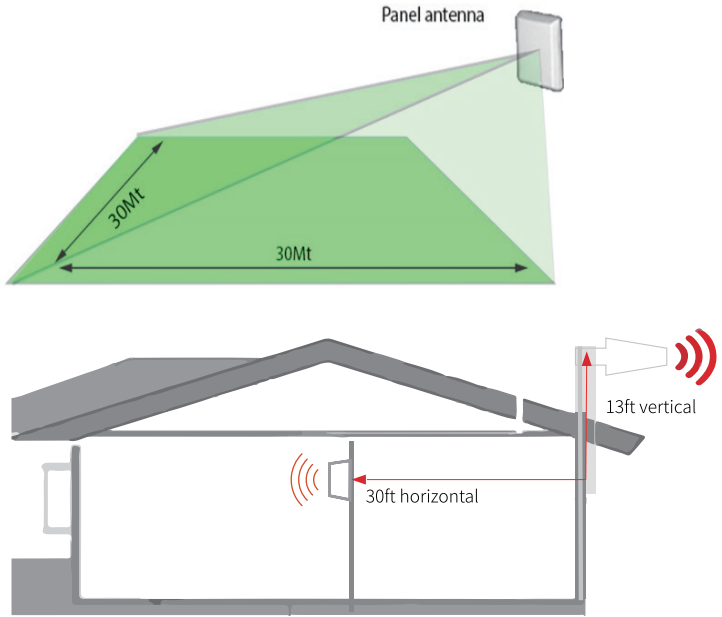

2) After finding the location, hold it there, and ask the other person to compare the gain and power on LCD signal meter, they shall keep the same or very nearby with the photo taken during outdoor antenna install. This is to avoid the loop back between outdoor and indoor antennas, please move the indoor antenna till you get unchanged or slightly changed gain and power. This step is quite crucial for the booster's best performance.



==



Two requests of indoor antenna install

- A. Radiation shall be good enough to cover whole space
- B. Loop back shall be avoided

Again the tips to avoid the loop back

1. Increase the distance between the outdoor and indoor antennas
2. The outdoor and indoor antennas shall be back to back
3. Use barriers between the indoor and outdoor antennas

Notes about LCD Display

These are instructions that will allow users to install a Super/Ultra Signal cell phone booster using the LCD Display.

Following LED status indicators and control buttons on the booster .

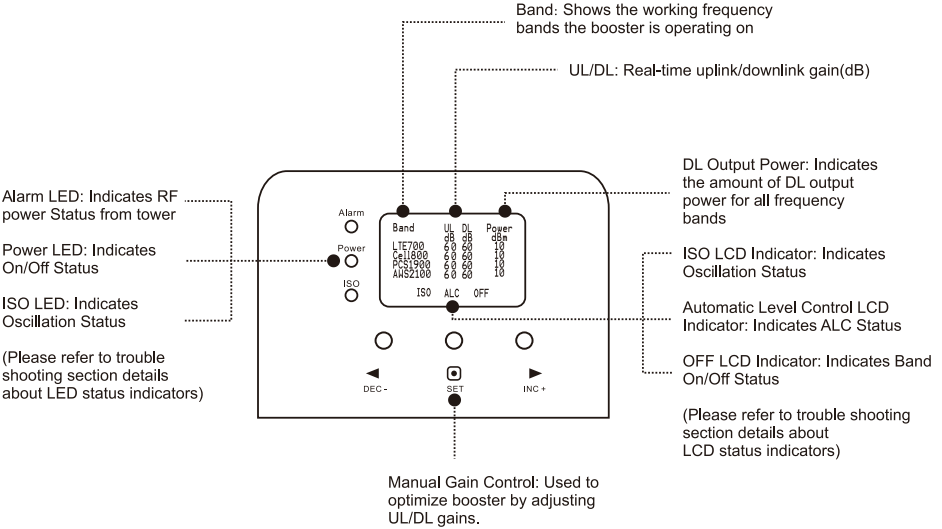

LED/LCD STATUS INDICATORS	
Alarm LED	Indicates RF Power Status from tower
Power LED	Indicates ON/OFF Status
ISO LED	Indicates Oscillation Status
Manual Gain Control	Used to optimize booster by adjustment of UL/DL
OFF LCD Indicator	Indicates Band ON/OFF Status
Automatic Level Control	Indicates ALC Status
ISO LCD Indicator	Indicates Oscillation Status
DL Output Power	Realtime Uplink/Downlink Gain In dB
Bluetooth/Wi-Fi Indicator	Indicates Bluetooth and Wi-Fi are Enabled
UL/DL	Realtime Uplink and Downlink Gain
Band	Shows working frequency bands the booster is operating on

3.4 Signal quality test

After finding such a location, hold the indoor antenna there and ask the other person to walk back and forth, and use the 3rd party app to test the signal strength, voice, and data. We recommend you to test the signal strength, the voice quality and data speed.

*Notes Again: Just remember that strength and quality are two separate issues. A poor quality “strong” signal can be next to useless, but a clean signal of two bars might be all your device needs.

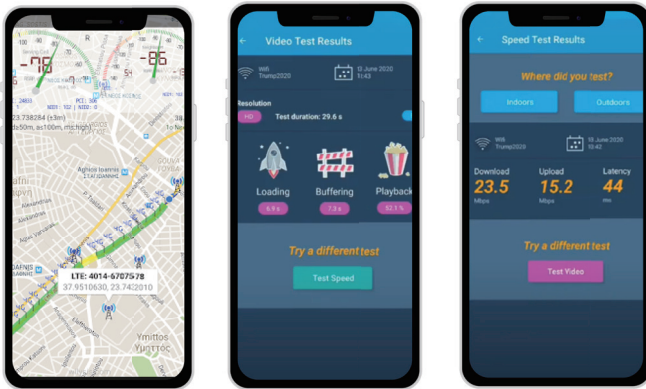

If the test is good, then congratulations, the indoor antenna position has been successfully found. Please install the indoor antenna.

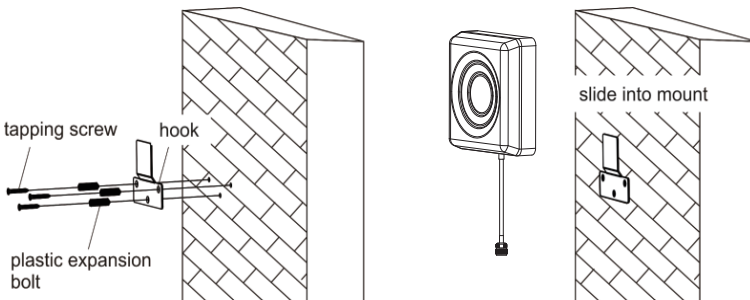

Step 4: Install the booster and the cables

Mount the signal booster in a dry and cool area, and it shall be easily accessible for maintenance.

And run the cables neatly, please do use the **water-proof tape** to protect all outside

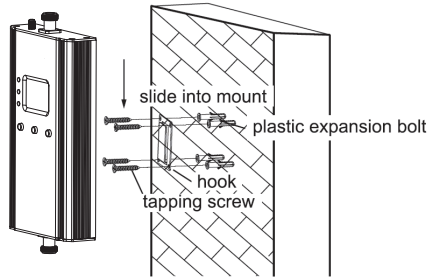

Test again the performance after installation is done

- First make sure the LCD gauge value is unchanged from the outdoor antenna install.
- Test by a third-party app, calls and network data are smooth in most indoor signal coverage areas.

- Now everything is completed and please start to enjoy the mobile services.
- If the result is not satisfactory or you want to be better, you may repeat the whole or part of the process to improve.
- Please contact us: Signal Supervisor app online support, Phone and Email in case you have any problems.

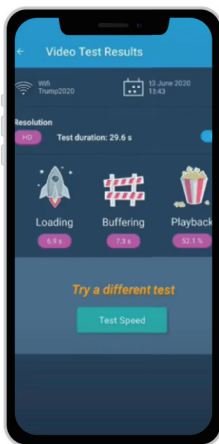

Band	UL	DL	Power
	dB	dB	dBm
LTE700	60	60	10
Ce11800	60	60	10
PCS1900	60	60	10
AWS2100	60	60	10
	ISO	ALC	OFF



Quick Troubleshooting Guide

Eliminate Flashing ISO LCD Display Indicator and Quick Flashing Green, Quick Flashing Red ISO LED Indicator problems:

1. Adjust the outdoor antenna direction, keeping it away from the indoor antenna-restart the booster.
2. Increase the vertical or horizontal distance between the outdoor antenna and the indoor antenna-restart booster.
3. Use metal or wall barriers to increase the isolation between the indoor and outdoor antennas-restart booster.
4. Change the indoor antenna type to an antenna with a more directional antenna pattern-orient the indoor antenna and the outdoor antenna so they are not pointing at each other.

The ISO issues are solved when the ISO LED is "Green" or "Slow Flashing Green" or no flashing ISO legend.

Eliminate poor coverage problems when Power“ – – – ” legend on LCD and Alarm LED is Green

1. If the signal has not been improved, please check below:

- A weak downlink signal leads to the low output signal level-change the direction or position of the outdoor antenna.
- Try replacing the outdoor antenna with a higher gain antenna to increase the amount of signal being received.
- Check to see if it is necessary to add more indoor antennas-barriers such as walls can block the signal indoors.
- Check the booster to make sure the output power is maximized-the user may need to replace the booster with a more powerful one if the amount of outdoor signal available is limited.

2. If the signal in a small section of the building hasn't been improved, try the following:

- Check to see if the indoor antenna is installed correctly-try moving and adjusting the indoor antenna to improve coverage.

Other Troubleshooting Issues

Reference the chart below to identify the current status of the booster.

LED STATUS INDICATORS		
LED	STATUS	INDICATION
Alarm LED	GREEN	Below full output power
	SLOW FLASHING GREEN	Full output power
	QUICK FLASHING GREEN	Output power is too high
	QUICK FLASHING RED	Booster will automatically shut off due to excessive DL signal from tower
Power LED	GREEN	Normal
	OFF	DC Power Problem
ISO LED	GREEN	Indicates oscillation status
	SLOW FLASHING GREEN	Slight loop back or self-oscillation
	QUICK FLASHING GREEN	Deep loop back or self-oscillation
	QUICK FLASHING RED	Booster is automatically shutting off

If there are any issues while installing a HiBoost cell phone signal booster, please contact the technical support team through the following channels:

Online Support: Create a ticket or chat via Signal Supervisor app

 (972) 870-5666 (M-F from 9 am – 5 pm CST)

 service@hiboost.com

 www.hiboost.com

Technical Specifications

Model No.	4K Smart Link	10K Smart Link	15K Smart Link
Working Bands	Band 12/17/Band 13/Band 5/Band 25/2/Band 4		
UL Frequency Range	698-716 / 776-787 / 824-849 / 1850-1915 / 1710-1755		
DL Frequency Range	728-746 / 746-757 / 869-894 / 1930-1995 / 2110-2155		
Maximum Gain	60 dB	65 dB	70 dB
Maximum Output Power	DL 10 dBm	DL 12 dBm	
I/O Port	F-Female	N-Female	
Weight	> 4.0 lb / 1.8 kg	> 5.0 lb / 2.2 kg	
Dimensions	4.7in x 7.8in x 1.4in / 120mm x 198mm x 34mm	8.6in x 6.5in x 2in / 218mm x 165mm x 50mm	
MGC(Step Attenuation)	>25 dB / 1 dB Step		
Impedance	50 ohm		
Environment Condition	IP40		
Power Supply	Input AC 100~240V, 50/60Hz, Output DC 12 V/3 A		

Notes: Support 5G only that's been or will be deployed in current 4G by DSS (Dynamic Spectrum Sharing) by carriers.

Authorized Accessories List

Outdoor Antenna & Cable Kit Options

Kit 9-5050

Yagi 9dbi Antenna & 50' 5D Cable

Kit 11-100400

Yagi 11dbi Antenna & 100' 400 Cable

Kit 11-7550

Yagi 11dbi Antenna & 75' 5D Cable

Kit 11-100500

Yagi 11dbi Antenna & 100' 5D Cable

Kit 10-3050

Panel 10dbi Antenna & 30' 5D Cable

Kit 10-50400

Panel 10dbi Antenna & 50' 400 Cable

Kit 10-5050

Panel 10dbi Antenna & 50' 5D Cable

Kit 10-75400

Panel 10dbi Antenna & 75' 400 Cable

Kit 10-100400

Panel 10dbi Antenna & 100' 400 Cable

Kit 10-7550

Panel 10dbi Antenna & 75' 5D Cable

Kit 10-10050

Panel 10dbi Antenna & 100' 5D Cable

Kit 9-50400

Yagi 9dbi Antenna & 50' 400 Cable

Kit 9-75400

Yagi 9dbi Antenna & 75' 400 Cable

Kit 9-100400

Yagi 9dbi Antenna & 100' 400 Cable

Kit 9-7550

Yagi 9dbi Antenna & 75' 5D Cable

Kit 9-10050

Yagi 9dbi Antenna & 100' 5D Cable

Kit 7-3050

Panel 7dbi Antenna & 30' 5D Cable

Kit 7-50400

Panel 7dbi Antenna & 50' 400 Cable

Kit 7-5050

Panel 7dbi Antenna & 50' 5D Cable

Kit 7-75400

Panel 7dbi Antenna & 75' 400 Cable

Kit 7-100400

Panel 7dbi Antenna & 100' 400 Cable

Kit 7-7550

Panel 7dbi Antenna & 75' 5D Cable

Kit 7-10050

Panel 7dbi Antenna & 100' 5D Cable

Kit 5-30400

Omni 5dbi Antenna & 30' 400 Cable

Kit 5-3050

Omni 5dbi Antenna & 30' 5D Cable

Kit 5-50400

Omni 5dbi Antenna & 50' 400 Cable

Kit 5-5050

Omni 5dbi Antenna & 50' 5D Cable

Kit 5-75400

Omni 5dbi Antenna & 75' 400 Cable

Kit 5-10400

Omni 5dbi Antenna & 100' 400 Cable

Kit 5-7550

Omni 5dbi Antenna & 75' 5D Cable

Kit 5-10050

Omni 5dbi Antenna & 100' 5D Cable

Indoor Antenna & Cable Kit Options

Kit 72-5050-50

2 Panel 7dbi Antenna with 50' 5D N male

& 2-Way Splitter

Kit 52-5050-50

2 Whip 5dbi Antenna & 50' 5D Cable

& 2-Way Splitter

Kit 102-5050-50

2 Panel 10dbi Antenna with 50' 5D N male

& 2-Way Splitter

Kit 103-7550-50

3 Panel 10dbi Antenna & 75' 5D Cable

& 3-Way Splitter

Kit 104-7550-50

4 Panel 10dbi Antenna & 75' 5D Cable

& 3 2-Way Splitter

Kit 73-7550-50

3 Panel 7dbi Antenna & 75' 5D Cable

& 3-Way Splitter

Kit 74-7550-50

4 Panel 7dbi Antenna & 75' 5D Cable

& 3 2-Way Splitter

Kit 3-30400

Omni 3dBi Antenna with 30' 400 Cable

Kit 3-5050

Omni 3dBi Antenna & 50' 5D Cable

Kit 3-7550

Omni 3dBi Antenna & 75' 5D Cable

Kit 3-10050

Omni 3dBi Antenna & 100' 5D Cable

Kit 3-30400

Omni 3dBi Antenna with 30' 400 Cable

Kit 3-50400

Omni 3dBi Antenna & 50' 400 Cable

Kit 32-50400-50

2Omni 3dBi Antenna & 50' 400 Cable

& 2-Way Splitter

Kit 33-50400-50

3 Omni 3dBi Antenna & 50' 400 Cable

& 3-Way Splitter

Kit 34-50400-50

4 Omni 3dBi Antenna & 50' 400 Cable

& 3 2-Way Splitter

NOTE:Unauthorized use of accessories (power supplies, antennas, cables, etc.) is strictly prohibited.

FCC and IC Statements

FCC RF EXPOSURE STATEMENT

This equipment complies with FCC radiation exposure limits set forth for an uncontrolled environment. End users must follow the specific operating instruction for satisfying RF exposure compliance. This transmitter must not be colocated or operating in conjunction with any other antenna or transmitter.

IC RF EXPOSURE STATEMENT

The device is in compliance with RF exposure limits. The minimum distance from body to use the device is 20 CM.

Le présent appareil est conforme aux normes de conformité ou aux limites d'intensité de champ RF. La distance minimale du corps à utiliser le dispositif est de 20 CM.

This equipment has been tested and found to comply with the limits for a Class B digital device, pursuant to part 15 of the FCC Rules. These limits are designed to provide reasonable protection against harmful interference in a residential installation. This equipment generates, uses and can radiate radio frequency energy and, if not installed and used in accordance with the instructions, may cause harmful interference to radio communications.

However, there is no guarantee that interference will not occur in a particular installation. If this equipment does cause harmful interference to radio or television reception, which can be determined by turning the equipment off and on, the user is encouraged to try to correct the interference by one or more of the following measures:

- Re-orient or relocate the receiving antenna.
- Increase the separation between the equipment and receiver
- Connect the equipment into an outlet on a circuit different from that to which the receiver is connected
- Consult the dealer or an experienced radio/TV technician for help

Changes or modifications not expressly approved by HiBoost could void the user's authority to operate the equipment. For a complete list of antennas and cables approved for use with these boosters see Authorized Kitting Options

FCC 27.50(d)(4) Statement: Fixed, mobile, and portable (handheld) stations operating in the 1710-1755 MHz band are limited to 1-watt EIRP. Fixed stations operating in the 1710-1755 MHz band are limited to a maximum antenna height of 10 meters above ground.

FURTHER INFORMATION ON SIGNAL BOOSTER END-USE REGISTRATION

The following links are the currently active contacts for booster registration with U.S. wireless providers:

<https://www.uscellular.com/uscellular/support/fcc-booster-registration.jsp>

https://www.sprint.com/legal/fcc_boosters.html

<https://www.verizonwireless.com/solutions-and-services/accessories/register-signal-booster/>

<https://support.t-mobile.com/docs/DOC-9827>

<https://securec45.securewebsession.com/attsignalbooster.com/>

IC Statement: This device complies with Innovation, Science and Economic Development Canada ICES-003 Compliance Label: CAN ICES-3 (B)/NMB-3(B). Le présent appareil est conforme Innovation, science et développement économique Canada ICES-003 Étiquette de conformité: CAN ICES-3 (B) / NMB-3 (B).

Please follow the link to access the CPC-2-1-05:

This is a CONSUMER device.

BEFORE USE, you **MUST REGISTER THIS DEVICE** with your wireless provider and have your provider's consent. Most wireless providers consent to the use of signal boosters. Some providers may not consent to the use of this device on their network. If you are unsure, contact your provider.

In Canada, **BEFORE USE**, you must meet all requirements set out in ISED CPC-2-1-05.

You **MUST** operate this device with approved antennas and cables as specified by the manufacturer. Antennas **MUST** be installed least 20 cm (8 inches) from (i. e. **MUST NOT** be installed within 20 cm of) any person.

You **MUST** cease operating this device immediately if requested by the FCC (or ISED in Canada) or a licensed wireless service provider.

WARNING. E911 location information may not be provided or may be inaccurate for calls served by using this device.

This device may be operated **ONLY** in a fixed location (i.e., may operate in a fixed location only) for in-building use.

Return and Warranty Policies

30-Day Money-Back Guarantee: If for any reason the performance of any product is not acceptable, the product may be returned to the reseller within 30-days with proof of purchase. Please contact the customer support team.

3-Year Warranty: Signal boosters and kits are warranted for 3 years. We will repair or replace the unit and will cover the cost of delivery back to consumers located within the continental US and Canada. We will only cover shipping to our office if the booster was delivered to you recently, and was delivered defective. Damage caused by the use of non-company power supplies or other accessories is not covered under warranty.

Customers can choose to return the signal boosters and kits directly to the manufacturer at the purchaser's expense with a dated proof of purchase and a Returned Material Authorization (RMA) number supplied by us. RMA numbers may be obtained by contacting customer support at 972-870- 5666 or support@hiboost.com

This warranty does not apply to any signal boosters or kits determined by us to have been subjected to tampering, misuse, abuse, neglect, or mishandling that alters or damages physical or electronic properties.

We are not liable for any Signal Supervisor application network connectivity issues. The cell phone signal booster relies on a strong, continuous and reliable connection to the internet in order to communicate with the cell phone application. For all Signal Supervisor Application related issues, please check your network strength and call our technical support.

Failure to use a surge-protected AC power strip with at least a 1000 Joule rating will void your warranty. Damage caused by lightning is not covered by this warranty.

All of the products that are packaged with other accessory products are intended for resale and used as a single integrated system. Such product kits are required to be sold to the end-users or subsequent reseller as packaged.